

Pfaff 142  
Subclass

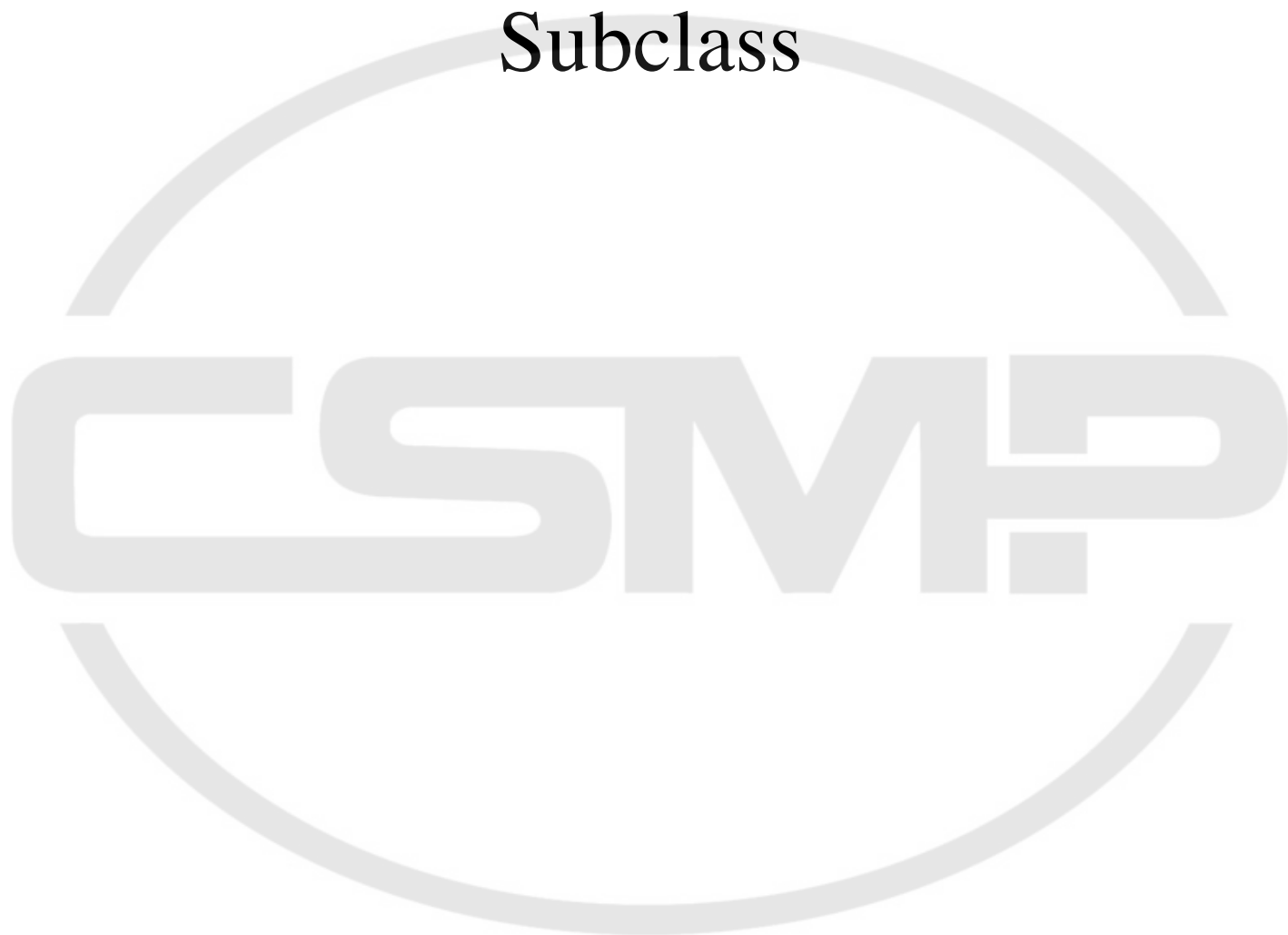

---

**PFAFF**<sup>®</sup> **142**



**Unterklassen-Ausstattung**

Subclass parts

Composition des sous-classes

Composición de las subclases

# Unterklassen-Ausstattung

# Subclass organization

Unterklasse Subclass Sous-classe Subclase	Ausführung Model Version Tipo de máquina	Nadelabstand in mm Needle gauge in mm Écartement des aiguilles en mm Distancia entre agujas en mm	Nadelstange Needle bar Barre à aiguille Barra de aguja	Stoffschieber Feed dog Griffe Transportador interior	Nadelplatte Needle plate Plaque à aiguille Placa de aguja	Nähfuß Presser foot Pied presseur Pie prensaleña
-6/01*	A	0,8- 2,0	91-715 538-93 x 3,2 <sup>4/7/1</sup>	91-040 340-04	91-040 341-04	91-040 791-04
-6/01*	B; BN	1,2- 2,2	91-715 538-93 x 3,2 <sup>4/7/1</sup>	91-040 340-04	91-040 341-04	91-040 791-04
-6/01*	B; BN	2,4- 3,2	91-710 005-93	91-046 714-04 <sup>10/1</sup>	91-046 715-04 <sup>10/1</sup>	91-040 811-03
-6/01*	B; BN	4,0- 5,6	91-710 005-93	91-046 734-04	91-046 735-04	91-040 811-03
-6/01*	B; BN	6,0-34,0	91-710 005-93	91-046 714-04 <sup>10/1</sup>	91-046 715-04 <sup>10/1</sup>	91-040 811-03
-6/01*	B; BN	36,0	91-710 261-93	91-046 714-04 <sup>10/1</sup>	91-046 715-04 <sup>10/1</sup>	91-040 811-03
-6/01*	B; BN	38,0-72,0	91-710 261-93	91-047 261-93 <sup>10/1</sup>	91-046 715-04 <sup>10/1</sup>	91-040 811-03
-6/03*	B; BN	4,0-72,0	XXX	XXX	XXX	91-046 895-93 <sup>10</sup> = 4,0-11,2 mm 91-046 900-93 <sup>10</sup> = 12,0-22,0 mm 91-046 905-93 <sup>10</sup> = 24,0-72,0 mm
-6/07	A; B	4,0- 8,0	91-710 005-93	91-045 492-04	91-045 493-04	91-040 811-03
-42/04*	B; BN	12,0-72,0	XXX	XXX	XXX	91-046 900-93 <sup>10</sup> = 12,0-22,0 mm 91-046 905-93 <sup>10</sup> = 24,0-72,0 mm
-42/05*	B; BN	12,0-72,0	XXX	XXX	XXX	91-046 900-93 <sup>10</sup> = 12,0-22,0 mm 91-046 905-93 <sup>10</sup> = 24,0-72,0 mm
-57/01*	B; BN	4,0-20,0	XXX	XXX	XXX	XXX
-57/02*	B; BN	4,0-10,0	XXX	XXX	XXX	XXX
-57/03*	B; BN	4,0-10,0	XXX	XXX	XXX	XXX
-57/04*	B; BN	4,0-10,0	XXX	XXX	XXX	91-040 662-03 <sup>5</sup>
-58/01*	B; BN	4,0-20,0	XXX	XXX	XXX	XXX
-58/02*	B; BN	4,0-10,0	XXX	XXX	XXX	XXX
-58/03*	B; BN	4,0-10,0	XXX	XXX	XXX	XXX
-58/04*	B; BN	4,0-10,0	XXX	XXX	XXX	91-040 663-03 <sup>5</sup>
-59/01	B	4,8-24,0	91-710 005-93	91-026 583-04	91-026 574-93 <sup>5</sup>	91-026 578-03 <sup>5</sup>
-59/02*	B; BN	6,0-72,0	XXX	XXX	XXX	XXX
-59/11*	B; BN	4,8-24,0	XXX	XXX	XXX	91-026 578-03 <sup>5</sup>
-61/01*	B; BN	2,4-24,0	XXX	XXX	XXX	91-026 578-03 <sup>5</sup>

XXX Teilenummer aus dem Nadelabstandsbereich der Unterklasse -6/01 entnehmen.

Select part number from range of needle gauges in subcl. -6/01

Pour le numéro de pièce voir les écartements d'aiguille de la ss-cl. -6/01

Para el número de pieza, véanse las distancias entre agujas para la subclase -6/01

<sup>4</sup> = Ausführung angeben  
= Indicate model  
= Préciser la version  
= Indique el tipo de máquina

<sup>5</sup> = Nahmuster einsenden  
= Submit sewing sample  
= Joindre échantillons de couture  
= Envíese muestra de costura

<sup>10</sup> = Nadelabstand  
= Needle gauge  
= Écartement des aiguilles  
= Distancia entre agujas

<sup>10/1</sup> = je nach Nadelabstand ändert sich die Form (z. B. beim Stoffschieber die Anzahl der Zahnreihen)  
= Certain design features change according to the needle gauge (e. g. the number of tooth rows on the feed dog)  
= La forme est fonction de l'écartement des aiguilles (par ex. le nombre des rangées de dents de la griffe).  
= La forma varía de acuerdo con la distancia entre agujas (p. ej. el número de hileras de dientes en el transportador)

Equipement des sous-classes

Dotación de las subclases

Apparat Attachement Appareil Aparato	Träger Brachet Support Soporte	Kopfplatte Face plate Plaque frontale Placa frontal	Bandtrommel Tape reel Tambour porte-cintas	Bandführung Tape guide Guide-ruban Guiacintas	Fingerschutz Finger guard Protège-digits Salvadedos
					91-046 864-25
					91-046 864-25
91-045 235-23 91-041 906-23	91-040 862-90 91-040 528-90	91-040 766-91	91-040 207-91		
91-053 131-23	91-040 528-90				
91-040 317-93 <sup>19.2</sup> 91-042 068-23 <sup>19.2</sup>	<sup>19.2</sup> = 4,0-10,0 mm <sup>19.2</sup> = 11,2-20,0 mm				
91-042 615-93					
91-042 218-93			91-041 644-91	91-044 419-25	
91-040 657-23 <sup>19.2</sup>			91-040 207-91		91-055 261-91 <sup>19.2</sup> = 4,0- 8,0 mm 91-055 259-91 <sup>19.2</sup> = 9,2-10,0 mm
91-040 316-93 <sup>19.2</sup> 91-040 814-23 <sup>19.2</sup>	<sup>19.2</sup> = 4,0-10,0 mm <sup>19.2</sup> = 11,2-20,0 mm				
91-042 614-93 <sup>19.2</sup>					
91-042 217-93 <sup>19.2</sup>			91-041 644-91	91-044 419-25	
91-040 656-23 <sup>19.2</sup>			91-040 207-91		91-055 261-91 <sup>19.2</sup> = 4,0- 8,0 mm 91-055 259-91 <sup>19.2</sup> = 9,2-10,0 mm
			91-040 207-91 91-041 644-91	91-044 419-25	91-055 261-91 <sup>19.2</sup> = 4,0- 8,0 mm 91-055 259-91 <sup>19.2</sup> = 9,2-10,0 mm
91-043 408-23 91-042 429-23	91-040 862-90 91-040 528-90	91-040 766-91	91-040 207-91 91-041 644-91	91-044 419-25	
91-042 369-21			91-040 207-91 91-041 644-91	91-044 419-25	91-055 261-91 <sup>19.2</sup> = 4,8- 8,0 mm 91-055 259-91 <sup>19.2</sup> = 9,2-24,0 mm
c			91-040 207-91		91-055 261-91 <sup>19.2</sup> = 4,8- 8,0 mm 91-055 259-91 <sup>19.2</sup> = 9,2-24,0 mm

Fortsetzung siehe nächste Seite  
Continued on next page  
Suite voir page suivante  
Continúa en la página siguiente



<sup>19.2</sup> = Nadelabstand bei Bestellung angeben  
= State needle gauge on order  
= Indiquer écartement des aiguilles à la commande  
= Indíquese en los pedidos la distancia entre agujas

<sup>19.2</sup> = Nadel/diagonalabstand bei Bestellung angeben  
= Please state diagonal needle distance on order  
= Prière d'indiquer l'espacement diagonal des aiguilles à la commande  
= Indíquese en los pedidos la distancia diagonal entre agujas

# Unterklassen-Ausstattung

# Subclass organization

Unterklasse Subclass Sous-classe Subclase	Ausführung Model Version Tipo de máquina	Nadelabstand in mm Needle gauge in mm Écartement des aiguilles Distancia entre agujas en mm	Nadelstange Needle bar Barre à aiguille Barrera de aguja	Stoffschieber Feed dog Griffe Transportador inferior	Schutzplatte Coudre plate Plaque à aiguille Placa de aguja	Nahmaß Esser Pie presser Pie prensatejas	Apparat Attachement Appareil Aparato
-61/02*	B; BN	6,0-72,0	XXX	XXX	XXX		91-043 408-23
-61/04	B	4,0- 5,6	91-710 005-93	91-045 492-04	91-045 493-04	91-026 850-03	
-61/04*	B	6,0-24,0	XXX	XXX	XXX	91-026 850-03	
-61/09*	B; BN	2,4-24,0	XXX	XXX	XXX	91-040 584-03 <sup>[1]</sup>	
-61/21*	B	6,0-20,0	XXX	XXX	XXX	91-043 767-93 <sup>[1]</sup>	
-63/02*	B; BN	6,0-24,0	XXX	XXX	XXX	91-040 845-03	91-042 429-23
-63/03*	B; BN	2,4-24,0	XXX	XXX	XXX	91-040 845-03	91-042 396-21
-65/01*	B; BN	2,4-24,0	XXX	XXX	XXX	XXX	91-041 848-23 <sup>[1,2]</sup>
-67/04*	B; BN	6,0-72,0	XXX	XXX	XXX	91-046 895-93 <sup>[1]</sup> = 6,0-11,2 mm 91-046 900-93 <sup>[1]</sup> = 12,0-22,0 mm 91-046 905-93 <sup>[1]</sup> = 24,0-72,0 mm	91-040 769-23 <sup>[1,2]</sup> 91-041 906-23
-67/12*	B; BN	2,4-20,0	XXX	XXX	XXX	91-026 758-23 <sup>[1]</sup>	91-041 906-23
-69/01*	B; BN	2,4-20,0	XXX	XXX	XXX	91-026 758-23 <sup>[1]</sup>	
-69/02*	B; BN	6,0-72,0	XXX	XXX	XXX	XXX	91-040 769-23 <sup>[1,2]</sup>
-69/11*	B; BN	6,0-24,0	XXX	XXX	XXX	91-041 615-24 <sup>[1]</sup>	
-69/12*	B; BN	6,0-24,0	XXX	XXX	XXX	91-040 584-03 <sup>[1]</sup>	91-040 769-23 <sup>[1,2]</sup>
-70/01*	B; BN	6,0-72,0	XXX	XXX	XXX	XXX	91-026 588-23 <sup>[1,2]</sup>
-70/02*	B; BN	6,0-72,0	XXX	XXX	XXX	XXX	91-044 734-23 <sup>[1,2]</sup>
-71/01*	B; BN	6,0-24,0	XXX	XXX	XXX	91-026 758-23 <sup>[1]</sup>	91-026 588-23 <sup>[1,2]</sup>
-71/02*	B; BN	6,0-72,0	XXX	XXX	XXX	XXX	91-040 769-23 <sup>[1,2]</sup> 91-044 734-23 <sup>[1,2]</sup>
-71/12*	B; BN	6,0-24,0	XXX	XXX	XXX	91-026 758-23 <sup>[1]</sup>	91-044 734-23 <sup>[1,2]</sup>
-72/01	B	4,8-24,0	91-710 005-93	91-026 583-04	91-026 574-93 <sup>[1]</sup>	91-040 811-03	
-72/02*	B; BN	6,0-72,0	XXX	XXX	XXX	XXX	91-042 429-23

XXX Teilenummer aus dem Nadelabstandsbereich der Unterklasse -6/01 entnehmen.

Select part number from range of needle gauges in subcl. -6/01

Pour le numéro de pièce voir les écartements d'aiguille de la ss-cl. -6/01

Para el número de pieza, véanse las distancias entre agujas para la subclase -6/01

[1] = Ausführung angeben  
= Indicate model  
= Préciser la version  
= Indíquese el tipo de máquina

[1,2] = Nähmuster einsenden  
= Submit sewing sample  
= Joindre échantillons de couture  
= Envíese muestra de costura

[10,2] = Nadelabstand  
= Needle gauge  
= Écartement des aiguilles  
= Distancia entre agujas

[10,2] = Nadelabstand bei Bestellung angeben  
= State needle gauge on order  
= Indiquer écartement des aiguilles à la commande  
= Indíquese en los pedidos la distancia entre agujas

Equipement des sous-classes

Dotación de las subclases

Träger Bracket Support Soporte	Kopfplatte Face plate Plaque frontale Placa frontal	Bandtrommel Tape reel Tambour-cârouleur Tambor portacintas	Bandführung Tape guide Guide-roulan Guías cintas	Fingerschutz Finger guard Protege-dedós Salvadedós	Lineal Edge guide Guide-croît Guía recta
91-040 862-90	91-040 766-91	91-040 207-91			
		91-040 207-91		91-055 261-91	91-040 064-25
		91-040 207-91		91-055 261-91 $\text{⑩}$ = 6,8- 8,0 mm 91-055 259-91 $\text{⑩}$ = 9,2-24,0 mm	91-040 064-25
				91-046 864-25 $\text{⑩}$ = 2,4- 6,8 mm 91-046 866-25 $\text{⑩}$ = 7,2-12,8 mm 91-046 868-25 $\text{⑩}$ = 13,2-20,0 mm 91-046 870-24 $\text{⑩}$ $\text{⑪}$ = 22,0-24,0 mm	
		91-040 207-91		91-055 261-91 $\text{⑩}$ = 6,0- 8,0 mm 91-055 259-91 $\text{⑩}$ = 9,2-20,0 mm	
91-040 528-90		91-041 644-91	91-044 419-25	91-046 864-25 $\text{⑩}$ = 6,0- 6,8 mm 91-046 866-25 $\text{⑩}$ = 7,2-12,8 mm 91-046 868-25 $\text{⑩}$ = 13,2-20,0 mm 91-046 870-24 $\text{⑩}$ $\text{⑪}$ = 22,0-24,0 mm	
		91-041 644-91	91-044 419-25	91-046 864-25 $\text{⑩}$ = 2,4- 6,8 mm 91-046 866-25 $\text{⑩}$ = 7,2-12,8 mm 91-046 868-25 $\text{⑩}$ = 13,2-20,0 mm 91-046 870-24 $\text{⑩}$ $\text{⑪}$ = 22,0-24,0 mm	
91-040 862-90 91-040 528-90	91-040 766-91	91-040 207-91			
91-040 528-90		91-040 207-91			
		91-040 207-91			
91-040 862-90	91-040 766-91	91-040 207-91		91-055 261-91 $\text{⑩}$ = 6,0- 8,0 mm 91-055 259-91 $\text{⑩}$ = 9,2-24,0 mm	
91-040 862-90	91-040 766-91	91-040 207-91		91-055 261-91 $\text{⑩}$ = 6,0- 8,0 mm 91-055 259-91 $\text{⑩}$ = 9,2-24,0 mm	
		91-041 644-91	91-044 419-25		
91-040 528-90		91-041 644-91	91-044 419-25		
		91-040 207-91 91-041 644-91	91-044 419-25		
91-040 862-90 91-040 528-90	91-040 766-91	91-040 207-91 91-041 644-91	91-044 419-25		
91-040 528-90		91-040 207-91 91-041 644-91	91-044 419-25		
		91-041 644-91	91-044 419-25		
91-040 528-90		91-041 644-91	91-044 419-25		

Fortsetzung siehe nächste Seite  
Continued on next page  
Suite voir page suivante  
Continúa en la página siguiente



# Unterklassen-Ausstattung

# Subclass organization

Unterklasse Subclass Subclasse	Ausführung Model Version Tipo de máquina	Nadelabstand in mm Needle gauge in mm Écartement des aiguilles en mm Distancia entre agujas en mm	Nadelstange Needle bar Barre à aiguille Barra de aguja	Stoffschieber Feed dog Griffe Transportador inferior	Sichplatte Needle plate Plaque & aiguille Placa de aguja	Nähfuß Presser foot Pie pressateur Pie prensatejas	Apparat Attachment Appareil Aparato
-72/04*	B; BN	6,0-24,0	XXX	XXX	XXX		91-044 989-23
-78/01*	B; BN	4,0-24,0	XXX	XXX	XXX		91-040 140-23
-82/02*	B; BN	6,0-72,0	XXX	XXX	XXX	91-046 895-93 <sup>10</sup> = 6,0-11,2 mm 91-046 900-93 <sup>10</sup> = 12,0-22,0 mm 91-046 905-93 <sup>10</sup> = 24,0-72,0 mm	91-043 408-23 91-041 906-23
-82/12*	B; BN	4,8-24,0	XXX	XXX	XXX	91-026 578-03 <sup>3</sup>	91-041 906-23
-83/01*	B; BN	4,8-10,0	XXX	XXX	XXX	XXX	91-050 002-23
-84/01*	B; BN	4,8-24,0	XXX	XXX	XXX	91-026 578-03 <sup>3</sup>	91-040 142-23 <sup>10 2</sup>
-85/01*	B; BN	4,8-24,0	XXX	XXX	XXX	XXX	91-050 002-23
-89/11*	B; BN	14,0-20,0	XXX	XXX	XXX	91-489 707-03	91-491 284-23
-94/02*	B; BN	4,8-30,0	XXX	XXX	XXX	XXX	91-046 014-23
-99/02*	B; BN	8,0-72,0	XXX	XXX	XXX	91-046 895-93 <sup>10</sup> = 8,0-11,2 mm 91-046 900-93 <sup>10</sup> = 12,0-22,0 mm 91-046 905-93 <sup>10</sup> = 24,0-72,0 mm	91-042 848-23 <sup>10 2</sup>
-108/01*	B; BN	4,8-20,0	XXX	XXX	XXX	91-046 895-93 <sup>10</sup> = 4,8-11,2 mm 91-046 900-93 <sup>10</sup> = 12,0-20,0 mm	91-041 731-23
-109/01*	B; BN	4,8-20,0	XXX	XXX	XXX	91-046 895-93 <sup>10</sup> = 4,8-11,2 mm 91-046 900-93 <sup>10</sup> = 12,0-20,0 mm	91-041 732-23
-110/01*	B; BN	4,8-20,0	XXX	XXX	XXX	91-026 758-23 <sup>3</sup>	91-040 142-23 <sup>10 2</sup>
-110/02*	B; BN	4,8-20,0	XXX	XXX	XXX	91-046 895-93 <sup>10</sup> = 4,8-11,2 mm 91-046 900-93 <sup>10</sup> = 12,0-20,0 mm	91-040 769-23 <sup>10 2</sup> 91-040 158-23
-113/01*	B; BN	4,8-10,0	XXX	XXX	XXX	91-026 804-03 91-026 805-03	
-116/02*	B; BN	12,0-50,0	XXX	XXX	XXX	XXX	91-042 350-24
-147/01*	B; BN	4,8-24,0	XXX	XXX	XXX	XXX	91-041 982-25
-148/01*	B; BN	4,8-24,0	XXX	XXX	XXX	XXX	91-040 815-23 <sup>10 2</sup>
-175/01*	B; BN	4,8-24,0	XXX	XXX	XXX	91-026 578-03 <sup>3</sup>	91-044 308-24
-177/02*	B; BN	10,0-24,0	XXX	XXX	XXX	XXX	91-044 438-93 <sup>10 2</sup>
-178/02*	B; BN	10,0-24,0	XXX	XXX	XXX	XXX	91-044 479-24
-189/01*	B; BN	2,4- 3,2	XXX	XXX	XXX	91-051 080-03	91-053 351-24
-189/02*	B; BN	2,4- 3,2	XXX	XXX	XXX	91-051 080-03	91-053 065-23
-230/01*	B; BN	8,0-24,0	XXX	XXX	XXX	91-051 516-93 <sup>10</sup> = 8,0-11,2 mm 91-051 517-93 <sup>10</sup> = 12,0-24,0 mm	91-053 534-93

XXX Teilenummer aus dem Nadelabstandsbereich der Unterklasse -6/01 entnehmen.

Select part number from range of needle gauges in subcl. -6/01

Pour le numéro de pièce voir les écartements d'aiguille de la ss-cl. -6/01

Para el número de pieza, véanse las distancias entre agujas para la subclase -6/01

<sup>1</sup> = Ausführung angeben  
= Indicate model  
= Préciser la version  
= Indiquese el tipo de máquina









<sup>2</sup> = Nähmuster einsenden  
= Submit sewing sample  
= Joindre échantillons de couture  
= Envíese muestra de costura

<sup>10</sup> = Nadelabstand  
= Needle gauge  
= Écartement des aiguilles  
= Distancia entre agujas

<sup>10 2</sup> = Nadelabstand bei Bestellung angeben  
= State needle gauge on order  
= Indiquer écartement des aiguilles à la commande  
= Indiquese en los pedidos la distancia entre agujas

Equipement des sous-classes

Dotación de las subclases

Träger Bracket Support Supporte	Kopfplatte Face plate Plaque frontale Placa frontal	Bandtrommel Tape reel Tambour dérouleur Tambor porticintas	Bandführung Tape guide Guide-riban Guacintas	Fingerschutz Finger guard Protecteur doigts Salvadedos	Lineal Edge guide Guide-droit Guia recta
91-040 528-90		91-042 742-91	91-044 419-25		
		91-041 644-91	91-044 419-25		
91-040 862-90 91-040 528-90	91-040 766-91	91-040 207-91			
91-040 528-90		91-040 207-91		91-055 261-91  = 4,8- 8,0 mm 91-055 259-91  = 9,2-24,0 mm	
		91-041 644-91	91-044 419-25		
		91-040 207-91		91-055 261-91  = 4,8- 8,0 mm 91-055 259-91  = 9,2-24,0 mm	
		91-041 644-91	91-044 419-25		
				91-046 868-25  = 14,0-20,0 mm	91-489 708-21 91-489 709-21
91-040 528-90		91-041 644-91	91-044 419-25		
91-040 528-90		91-041 644-91	91-044 419-25		
		91-041 644-91	91-044 419-25		
		91-041 644-91	91-044 419-25		
		91-040 207-91			
91-040 862-90	91-040 766-91	91-040 207-91			
				91-046 864-25  = 4,8- 6,8 mm 91-046 866-25  = 7,2-10,0 mm	
91-040 528-90		91-041 644-91	91-044 419-25		
		91-040 207-91			
		91-041 644-91	91-044 419-25		
91-040 528-90		91-041 644-91	91-044 419-25		
91-040 528-90		91-041 644-91	91-044 419-25		
		91-041 644-91	91-044 419-25	XXX	
91-040 528-90		91-042 742-91	91-044 419-25	91-046 864-25  = 2,4-3,2 mm	
				91-054 761-21	

Fortsetzung siehe nächste Seite  
Continued on next page  
Suite voir page suivante  
Continúa en la página siguiente





# Unterklassen-Ausstattung

# Subclass organization

Unterklass Subclass Sous-classe Subclasse	Ausführung Model Version Tipo de máquina	Nadelabstand in mm Needle gauge Ecartement des aiguilles en mm Distancia entre agujas en mm	Nadelstange Needle bar Barre à aiguille Barra de aguja	Stoffschieber Feed dog Griffe Transportador inferior	Stichplatte Needle plate Plaque à aiguille Placa de aguja	Nähfuß Presser foot Pied presseur Pie prensateelas	Apparat Attachment Appareil Aparato	Träger Bracket Support Soporte
-230/21*	B; BN	8,0-24,0	XXX	XXX	XXX	91-051 516-93 10 = 8,0-11,2 mm 91-051 517-93 10 = 12,0-24,0 mm	91-053 537-24	
-232/11*	B; BN	8,0-72,0	XXX	XXX	XXX	XXX	91-050 003-23	
-237/01*	B; BN	8,0-24,0	XXX	XXX	XXX	91-051 516-93 10 = 8,0-11,2 mm 91-051 517-93 10 = 12,0-24,0 mm	91-053 531-24	
-237/11	A	14,0-20,0	91-710 005-93	91-491 877-04 10 2	91-491 878-04 10 2	91-491 581-93 10 2	91-056 037-13	
-237/11 -900/11; /51	A	14,0-20,0	91-710 005-93	91-491 877-04 10 2	91-491 766-04 10 2	91-491 581-93 10 2	91-056 037-13	
-259/02	B	4,8- 8,0	91-710 005-93	91-045 492-04	91-491 935-04	91-051 376-03 10 2	91-491 934-23	91-053 936-90
-259/12	B	4,8- 8,0	91-710 005-93	91-045 492-04	91-491 935-04	91-054 560-03 10 2	91-491 934-23	91-053 936-90
-303/11*	B	10,0; 12,0	91-710 005-93	XXX	XXX	91-057 245-03	91-056 514-21	

\* Unterklasse kann mit Fadendurchzieh- und -abschneideeinrichtung in den Nadelabständen 0,8; 1,2; 2,0; 2,4; 3,2; 4,0; 4,8; 5,2; 5,6; 6,0; 6,4; 7,2; 8,0; 9,2; 10,0; 11,2; 12,0; 13,2; 14,0; 15,2; 16,0; 18,0; 20,0; 24,0; 25,2; 26,0; 28,0 und 30,0 mm geliefert werden, jedoch nur unter Berücksichtigung des in der Tabelle angegebenen Nadelabstandsbereichs.  
Bei Maschinen mit -900/11 und /51 ändern sich folgende Bestellnummern: Stoffschieber von 91-046 714-04 (nur bei 2,4 mm Nadelabstand) in 91-040 340-04, Nähfuß von 91-040 811-04 (nur bei 2,4 mm Nadelabstand) in 91-040 791-04 und die Stichplatten 91-040 341-04, 91-046 714-04 bzw. 91-046 735-04 in 91-058 092-04.  
Bei Maschinen mit -900/16 und /56 ändern sich folgende Bestellnummern: Stoffschieber von 91-046 714-04 (nur bei 2,4 mm Nadelabstand) in 91-040 340-04, Nähfuß von 91-040 811-04 (nur bei 2,4 mm Nadelabstand) in 91-040 791-04 und die Stichplatten 91-040 341-04, 91-046 715-04 bzw. 91-046 735-04 in 91-058 871-04.

\* This subclass can be supplied with thread puller/trimmer in needle gauges of 0,8, 1,2, 2,0, 2,4, 3,2, 4,0, 4,8, 5,2, 5,6, 6,0, 6,4, 7,2, 8,0, 9,2, 10,0, 11,2, 12,0, 13,2, 14,0, 15,2, 16,0, 18,0, 20,0, 24,0, 25,2, 26,0, 28,0 and 30,0 mm, provided they fall within the needle gauge range listed in the table.  
For machines with -900/11 and /51 the ordering number of the feed dog is changed from 91-046 714-04 (for 2,4 mm needle gauge only) to 91-040 340-04, that of the presser foot from 91-040 811-04 (for 2,4 mm needle gauge only) to 91-040 791-04, and those of the needle plates from 91-040 341-04, 91-046 714-04 and 91-046 735-04 to 91-058 092-04.  
For machines with -900/16 and /56 the ordering number of the feed dog is changed from 91-046 714-04 (for 2,4 mm needle gauge only) to 91-040 340-04, that of the presser foot from 91-040 811-04 (for 2,4 mm needle gauge only) to 91-040 791-04, and those of the needle plates from 91-040 341-04, 91-046 715-04 and 91-046 735-04 to 91-058 871-04.

XXX Select part number from range of needle gauges in subcl. -6/01

XXX Teilenummer aus dem Nadelabstandsbereich der Unterklasse -6/01 entnehmen.

4 = Ausführung angeben  
= Indicate model  
= Préciser la version  
= Indiquese el tipo de máquina

3 = Nähmuster einsenden  
= Submit sewing sample  
= Joindre échantillons de couture  
= Enviase muestra de costura

10 = Nadelabstand  
= Needle gauge  
= Ecartement des aiguilles  
= Distancia entre agujas

10 2 = Nadelabstand bei Bestellung angeben  
= State needle gauge on order  
= Indiquer écartement des aiguilles à la commande  
= Indiquese en los pedidos la distancia entre agujas

## Equipement des sous-classes







## Dotación de las subclases

Kopfplatte Face plate Plaque frontale Placa frontal	Bandtrommel Tape reel Tambour-dérouleur Tambor portacintas	Bandführung Tape guide Cintec-ruban Cintas	Fingerschutz Finger guard Protège-digits Salvadedos	Lagebock Basis block Chevalot de palier Soporte de apoyo	Lüfterhebel Lifting lever Lever relieveur Palanca alzaprensateletas	Botzen Stud Boulon Perno	Seilzug Pulit cable Transmission par câble Cable de mando
--------------------------------------------------------------	---------------------------------------------------------------------	-----------------------------------------------------	--------------------------------------------------------------	-------------------------------------------------------------------	------------------------------------------------------------------------------	-----------------------------------	--------------------------------------------------------------------

91-054 761-21

91-041 644-91 91-044 419-25

91-054 761-21

91-491 565-45		91-046 866-25  = 14,0-20,0 mm	91-108 583-91	91-108 589-41 91-010 796-15	91-108 594-05	91-108 595-91
91-491 565-45		91-046 866-25  = 14,0-20,0 mm	91-108 583-91	91-108 589-41 91-010 796-15	91-108 594-05	91-108 595-91
	91-053 325-91	91-044 419-25	91-046 864-25  = 4,8-6,8 mm			
			91-046 866-25  = 7,2-8,0 mm			
	91-053 325-91	91-044 419-25	91-046 864-25  = 4,8-6,8 mm			
			91-046 866-25  = 7,2-8,0 mm			
91-040 762-45	91-056 524-11 91-056 532-91	91-056 517-91 91-056 522-21 91-056 526-21				

\* Sous-classe livrable avec coupe-fil et dans les écartements d'aiguille de 0,8; 1,2; 2,0; 2,4; 3,2; 4,0; 4,8; 5,2; 5,6; 6,0; 6,4; 7,2; 8,0; 9,2; 10,0; 11,2; 12,0; 13,2; 14,0; 15,2; 16,0; 18,0; 20,0; 24,0; 25,2; 26,0; 28,0 et 30,0 mm, mais en tenant compte des écartements d'aiguille indiqués dans le tableau.

Pour les machines avec -900/11 et /51 les numéros de commande suivants sont modifiés: au lieu de la griffe n° 91-046 714-04 (uniquement pour écartement d'aiguille de 2,4 mm) dorénavant n° 91-040 340-04; au lieu du pied presseur n° 91-040 811-04 (uniquement pour écartement d'aiguille de 2,4 mm) dorénavant n° 91-040 791-04 et au lieu des plaques à aiguille n° 91-040 341-04, 91-046 715-04 et 91-046 735-04 dorénavant n° 91-058 092-04. Pour les machines avec -900/16 et /56 les numéros de commande suivants sont modifiés: au lieu de la griffe n° 91-046 714-04 (uniquement pour écartement d'aiguille de 2,4 mm) dorénavant n° 91-040 340-04, au lieu du pied presseur n° 91-040 811-04 (uniquement pour écartement d'aiguille de 2,4 mm) dorénavant n° 91-040 791-04 et au lieu des plaques à aiguille n° 91-040 341-04, 91-046 715-04 et 91-046 735-04 dorénavant n° 91-058 871-04.

XXX Pour le numéro de pièce voir les écartements d'aiguille de la ss-cl. -6/01

\* La subclasse se puede suministrar con cortahilos automático y en las siguientes distancias entre agujas: 0,8; 1,2; 2,0; 2,4; 3,2; 4,0; 4,8; 5,2; 5,6; 6,0; 6,4; 7,2; 8,0; 9,2; 10,0; 11,2; 12,0; 13,2; 14,0; 15,2; 16,0; 18,0; 20,0; 24,0; 25,2; 26,0; 28,0 y 30,0 mm, pero siempre teniendo en cuenta las distancias entre agujas indicadas en la tabla.

Para máquinas con 900/11 y /51 tienen lugar las siguientes sustituciones de números de pedido: el N° del transportador inferior 91-046 714-04 (sólo para distancia entre agujas de 2,4 mm) se sustituye por el N° 91-040 340-04; el N° del prensateletas 91-040 811-04 (sólo para distancia entre agujas de 2,4 mm) se sustituye por el N° 91-040 791-04 y los N° de las placas de aguja 91-040 341-04, 91-046 715-04 y 91-046 735-04 se sustituyen por el N° 91-058 092-04.

Para máquinas con -900/16 y /56, tienen lugar las siguientes sustituciones de números de pedido: el N° del transportador inferior 91-046 714-04 (sólo para distancia entre agujas de 2,4 mm) se sustituye por el N° 91-040 340-04; el N° del prensateletas 91-040 811-04 (sólo para distancia entre agujas de 2,4 mm) se sustituye por el N° 91-040 791-04 y los N° de las placas de aguja 91-040 341-04, 91-046 715-04 y 91-046 735-04 se sustituyen por el N° 91-058 871-04.

XXX Para el número de pieza, véanse las distancias entre agujas para la subclase -6/01

## Unterklassen-Ausstattung

## Subclass organization

Unterklasse Subclass Sous-classe Subclase	Ausführung Model Version Tipo de máquina	Nadelabstand in mm Needle gauge in mm Ecartement des aiguilles en mm Distancia entre agujas en mm	Nadelstange <sup>1</sup> Needle bar barra à aiguille Barra de aguja	Nadelhalter <sup>1,2</sup> Needle holder porte-aiguille Portaaiguja	Stoffschieber <sup>1,10,2</sup> Feed dog Griffe Transportador interior	Stichplatte <sup>1,10,2</sup> Needle plate Plaque à aiguille Placa de aguja
-720/02 -6/01	A	1,6- 2,4	91-019 879-93	91-019 916-93	91-046 714-04	91-046 715-04
-720/02 -6/01	B; BN	2,0- 2,8	91-019 879-93	91-019 916-93	91-046 714-04	91-046 715-04
-720/02 -6/01*	B; BN	3,2-30,0	91-019 865-93	91-019 930-93	91-046 714-04 <sup>10</sup> = 3,2 mm 91-046 734-04 <sup>10</sup> = 4,0-5,6 mm 91-046 714-04 <sup>10/21</sup> <sup>10</sup> = 6,0-30,0 mm	91-046 715-04 <sup>10</sup> = 3,2 mm 91-046 735-04 <sup>10</sup> = 4,0-5,6 mm 91-046 715-04 <sup>10/21</sup> <sup>10</sup> = 6,0-30,0 mm
-720/02 -6/03*	B; BN	4,0-30,0	91-019 865-93	91-019 930-93	91-046 734-04 <sup>10</sup> = 4,0-5,6 mm 91-046 714-04 <sup>10/21</sup> <sup>10</sup> = 6,0-30,0 mm	91-046 735-04 <sup>10</sup> = 4,0-5,6 mm 91-046 715-04 <sup>10/21</sup> <sup>10</sup> = 6,0-30,0 mm
-720/02 -6/07	A; B	4,0- 8,0	91-019 865-93	91-019 930-93	91-045 492-04	91-045 493-04
-720/02 -61/01	B; BN	2,4- 2,8	91-019 879-93	91-019 916-93	91-046 714-04	91-046 715-04
-720/02 -61/01*	B; BN	3,2-24,0	91-019 865-93	91-019 930-93	91-046 714-04 <sup>10</sup> = 3,2 mm 91-046 734-04 <sup>10</sup> = 4,0-5,6 mm 91-046 714-04 <sup>10/21</sup> <sup>10</sup> = 6,0-24,0 mm	91-046 715-04 <sup>10</sup> = 3,2 mm 91-046 735-04 <sup>10</sup> = 4,0-5,6 mm 91-046 715-04 <sup>10/21</sup> <sup>10</sup> = 6,0-24,0 mm
-720/02 -82/12*	B; BN	4,8-24,0	91-019 865-93	91-019 930-93	91-046 734-04 <sup>10</sup> = 4,8-5,6 mm 91-046 714-04 <sup>10/21</sup> <sup>10</sup> = 6,0-24,0 mm	91-046 735-04 <sup>10</sup> = 4,8-5,6 mm 91-046 715-04 <sup>10/21</sup> <sup>10</sup> = 6,0-24,0 mm
-720/02 -83/01*	B; BN	4,8-10,0	91-019 865-93	91-019 930-93	91-046 734-04 <sup>10</sup> = 4,8-5,6 mm 91-046 714-04 <sup>10/21</sup> <sup>10</sup> = 6,0-10,0 mm	91-046 735-04 <sup>10</sup> = 4,8-5,6 mm 91-046 715-04 <sup>10/21</sup> <sup>10</sup> = 6,0-10,0 mm
-720/02 -113/01*	B; BN	4,8-10,0	91-019 865-93	91-019 930-93	91-046 734-04 <sup>10</sup> = 4,8-5,6 mm 91-046 714-04 <sup>10/21</sup> <sup>10</sup> = 6,0-10,0 mm	91-046 735-04 <sup>10</sup> = 4,8-5,6 mm 91-046 715-04 <sup>10/21</sup> <sup>10</sup> = 6,0-10,0 mm

\* Unterklasse kann mit Fadendurchzieh- und -abschneideeinrichtung -900/... in den Nadelabständen 3,2; 4,0; 4,8; 5,2; 5,6; 6,0; 6,4; 7,2 und 8,0 mm geliefert werden, jedoch nur unter der Berücksichtigung des in der Tabelle angegebenen Nadelabstandsbereichs.  
Bei Maschinen mit -900/11 und /51 ändern sich folgende Bestellnummern: Stichplatte von 91-046 715-04 bzw. von 91-046 735-04 in 91-058 092-04.  
Bei Maschinen mit -900/16 und /56 ändern sich folgende Bestellnummern: Stichplatte von 91-046 715-04 bzw. von 91-046 735-04 in 91-058 871-04.

\* This subclass can be supplied with thread puller/trimmer in needle gauges of 3.2, 4.0, 4.8, 5.2, 5.6, 6.0, 6.4, 7.2 and 8.0 mm, provided they fall within the needle gauge range listed in the table.  
For machines with -900/11 and /51 the ordering numbers of the needle plates are changed from 91-046 715-04 and 91-046 735-04 to 91-058 092-04.  
For machines with -900/16 and /56 the ordering numbers of the needle plates are changed from 91-046 715-04 and 91-046 735-04 to 91-058 871-04.

<sup>1</sup> = Ausführung angeben  
= Indicate model  
= Préciser la version  
= Indíquese el tipo de máquina

<sup>1,2</sup> = Nahmuster einsenden  
= Submit sewing sample  
= Joindre échantillons de couture  
= Envíese muestra de costura

<sup>10</sup> = Nadelabstand  
= Needle gauge  
= Ecartement des aiguilles  
= Distancia entre agujas

Equipement des sous-classes

Dotación de las subclases

Nadeln <sup>10 2</sup> Presser foot Pie de prensalatas	Apparat <sup>5</sup> Attachment Appareil Aparato	Träger Bracket Support Soporte	Bandlommel Tape reel Tambour-dérouleur Tambor portacintas	Bandführung Tape guide Guide-riban Guías cintas	Fingerschutz Finger guard Protege-dedos Salvadores
91-040 811-03					
91-040 811-03					
91-040 811-03					
91-046 895-93 <sup>10</sup> = 4,0-11,2 mm 91-046 900-93 <sup>10</sup> = 12,0-22,0 mm 91-046 905-93 <sup>10</sup> = 24,0-30,0 mm					
91-040 811-03					
91-026 578-03 <sup>10</sup>			91-040 207-91		91-055 261-91
91-026 578-03 <sup>10</sup>			91-040 207-91		91-055 261-91 <sup>10</sup> = 3,2- 8,0 mm 91-055 259-91 <sup>10</sup> = 9,2-24,0 mm
91-026 578-03 <sup>10</sup>	91-041 906-23	91-040 528-90	91-040 207-91		91-055 261-91 <sup>10</sup> = 4,8- 8,0 mm 91-055 259-91 <sup>10</sup> = 9,2-24,0 mm
91-040 811-03	91-050 002-23		91-041 644-91	91-044 419-25	
91-026 804-03 91-026 805-03					91-046 864-25 <sup>10</sup> = 4,8- 8,0 mm 91-046 866-25 <sup>10</sup> = 9,2-10,0 mm

\* Sous-classe livrable avec coupe-fil -900/. . et dans les écartements d'aiguille de 3,2; 4,0; 4,8; 5,2; 5,6; 6,0; 6,4; 7,2 et 8,0 mm, mais en tenant compte des écartements d'aiguille indiqués dans le tableau.  
Pour les machines avec -900/11 et /51 les numéros de commande suivants sont modifiés: au lieu des plaques à aiguille n° 91-046 715-04 et 91-046 735-04 dorénavant n° 91-058 092-04.  
Pour les machines avec -900/16 et /56 les numéros de commande suivants sont modifiés: au lieu des plaques à aiguille n° 91-046 715-04 et 91-046 735-04 dorénavant n° 91-058 871-04.

\* La subclase se puede suministrar con cortahilos automático -900/. . y en las siguientes distancias entre agujas: 3,2; 4,0; 4,8; 5,2; 5,6; 6,0; 6,4; 7,2 y 8,0 mm, pero siempre teniendo en cuenta las distancias entre agujas indicadas en la tabla.  
Para máquinas con -900/11 y /51, los N°s de pedido de las placas de aguja 91-046 715-04 y 91-046 735-05 se sustituyen por el N° 91-058 092-04.  
Para máquinas con -900/16 y /56 los N°s de pedido de las placas de aguja 91-046 715-04 y 91-046 735-04 se sustituyen por el N° 91-058 871-04.

<sup>10 2</sup> = je nach Nadelabstand ändert sich die Form (z. B. beim Stoffschieber die Anzahl der Zahnreihen)  
= Certain design features change according to the needle gauge (e. g. the number of tooth rows on the feed dog)  
= La forme est fonction de l'écartement des aiguilles (par ex. le nombre des rangées de dents de la griffe)  
= La forma varía de acuerdo con la distancia entre agujas (p. ej. el número de hileras de dientes en el transportador)

<sup>10 2</sup> = Nadelabstand bei Bestellung angeben  
= State needle gauge on order  
= Indiquer écartement des aiguilles à la commande  
= Indíquese en los pedidos la distancia entre agujas

# Unterklassen-Ausstattung

# Subclass organization

Unterklassen Subclass Sous-classe Subclase	Ausführung Model	Typo de máquina Nadelabstand in mm Needle gauge in mm Ecartement des aiguilles en mm Distancia entre agujas en mm	Nadelstange <sup>10</sup> 2 Needle bar Barra de aguja	Stoffschieber <sup>4</sup> 10 2 Feed dog Griffe Transportador inferior	Stichplatte <sup>1</sup> 10 2 Necle plate Placa de aguja	Nahfuß <sup>1</sup> 10 2 Presser foot Pied presseur Pie prensateelas	Apparat <sup>3</sup> Attachment Accessori Aparato
-----------------------------------------------------	---------------------	-------------------------------------------------------------------------------------------------------------------------------------	-------------------------------------------------------------	---------------------------------------------------------------------------------	----------------------------------------------------------------	-------------------------------------------------------------------------------	------------------------------------------------------------

## -732/03-...

-303/01	B	8,0-12,0	91-710 117-93	91-491-442-04	91-491 443-04	91-492 535-93
---------	---	----------	---------------	---------------	---------------	---------------

## -732/09-...(-900/16;/56) -732/11-...-900/16-910/01-911/03

-6/03	B	8,0-20,0	91-113 458-93	91-047 314-04	91-048 910-93*	91-054 590-93	
-263/02	B	8,0-20,0	91-113 458-93	91-047 314-04	91-048 910-93*	91-054 590-93	91-053 732-23
-263/50	B	8,0-20,0	91-113 458-93	91-047 314-04	91-048 910-93*	91-054 590-93	91-491 269-23
-273/01	B	8,0-20,0	91-113 458-93	91-047 314-04	91-048 910-93*	91-054 590-93	91-053 414-23
-273/50	B	8,0-20,0	91-113 458-93	91-047 314-04	91-048 910-93*	91-054 590-93	91-491 270-23
-274/11	B	8,0-20,0	91-113 458-93	91-047 314-04	91-048 910-93*	91-055 400-93	91-053 859-23
-274/12	B	8,0-20,0	91-113 458-93	91-047 314-04	91-048 910-93*	91-055 400-93	91-053 859-23
-274/15	B	10,0-20,0	91-113 458-93	91-047 314-04	91-048 910-93*	91-055 400-93	91-053 859-23
-274/16	B	8,0-20,0	91-113 458-93	91-047 314-04	91-048 910-93*	91-055 400-93	91-493 211-23
-274/17	B	8,0-20,0	91-113 458-93	91-047 314-04	91-048 910-93*	91-055 400-93	91-493 211-23
-274/51	B	8,0-20,0	91-113 458-93	91-047 314-04	91-048 910-93*	91-055 400-93	91-491 279-23
-274/52	B	8,0-20,0	91-113 458-93	91-047 314-04	91-048 910-93*	91-055 400-93	91-491 279-23
-293/11	B	8,0-20,0	91-113 458-93	91-047 314-04	91-048 910-93*	91-055 400-93	91-053 874-23
-293/12	B	8,0-20,0	91-113 458-93	91-047 314-04	91-048 910-93*	91-055 400-93	91-053 874-23
-293/15	B	10,0-20,0	91-113 458-93	91-047 314-04	91-048 910-93*	91-055 400-93	91-053 874-23
-293/16	B	8,0-20,0	91-113 458-93	91-047 314-04	91-048 910-93*	91-055 400-93	91-494 106-23
-293/17	B	8,0-20,0	91-113 458-93	91-047 314-04	91-048 910-93*	91-055 400-93	91-494 106-23
-293/18	B	10,0-20,0	91-113 458-93	91-047 314-04	91-048 910-93*	91-488 243-93 <sup>3</sup>	91-494 106-23
-293/19	B	10,0-20,0	91-113 458-93	91-047 314-04	91-048 910-93*	91-488 243-93 <sup>3</sup>	91-494 106-23
-293/51	B	8,0-20,0	91-113 458-93	91-047 314-04	91-048 910-93*	91-055 400-93	91-491 278-23
-293/52	B	8,0-20,0	91-113 458-93	91-047 314-04	91-048 910-93*	91-055 400-93	91-491 278-23
-299/10	B	10,0-20,0	91-113 458-93	91-047 314-04	91-048 910-93*	91-054 626-93	91-053 880-23
-363/02	B	12,0-20,0	91-113 458-93	91-047 314-04	91-048 910-93*	91-054 778-93	91-053 736-23
-363/50	B	12,0-20,0	91-113 458-93	91-047 314-04	91-048 910-93*	91-054 778-93	91-056 494-23
-393/11	B	12,0-20,0	91-113 458-93	91-047 314-04	91-048 910-93*	91-054 778-93	91-491 277-23
-393/12	B	12,0-20,0	91-113 458-93	91-047 314-04	91-048 910-93*	91-054 778-93	91-491 277-23

\* Bei Maschinen mit -900/16 und /56 hat die Stichplatte die Nr. 91-058 872-93.

\* On machines with -900/16 and /56 the ordering number of the needle plate is 91-058 872-93

\*\* Zum gleichzeitigen Befestigen von 2 Apparaten kann auf Wunsch der Träger Nr. 91-053 908-90 geliefert werden.

\*\* To fit two brackets simultaneously, bracket No 91-053 908-90 can be supplied on request.

<sup>1</sup> = Ausführung angeben  
= Indicate model  
= Préciser la version  
= Indiquese el tipo de máquina

<sup>3</sup> = Nähmuster einsenden  
= Submit sewing sample  
= Joindre échantillons de couture  
= Enviase muestra de costura

<sup>10</sup> = Nadelabstand  
= Needle gauge  
= Ecartement des aiguilles  
= Distancia entre agujas

Equipement des sous-classes

Dotación de las subclases

Träger Bracket Support Soporte	Kopfplatte Face plate Plaque frontale Placa frontal	Klammer Clamp Pinza	Patentführung Finger guide Cuchinet Guía para carteras	Reifverschleißführung Zipper guide Guide-lemeture à glissière Guía para cremalleras	Reifverschleiß- Trennvorrichtung Zipper separator Cuchinettenreife Contador de cremalleras	Messer Knife Couteau Cuchilla	Klemmleder Clamp spring Pesson de maintien Muelle de sujeción
					91-491-627-21		91-010 273-01
							91-113 460-01
							91-113 460-01
91-056 179-91**							91-113 460-01
							91-113 460-01
91-056 179-91**							91-113 460-01 91-129 661-15
91-056 278-90	91-113 464-91	91-113 451-25					91-113 460-01 91-129 661-15
91-056 278-90	91-113 464-91	91-113 451-25					91-113 460-01 91-129 661-15
91-056 278-90	91-113 464-91	91-113 451-25	91-053 869-93				91-113 460-01 91-129 661-15
91-056 278-90	91-113 464-91	91-113 451-25					91-113 460-01
91-056 278-90	91-113 464-91	91-113 451-25					91-113 460-01
91-056 179-91**							91-113 460-01
91-056 179-91**							91-113 460-01 91-129 661-15
91-056 278-90	91-113 464-91	91-113 451-25					91-113 460-01 91-129 661-15
91-056 278-90	91-113 464-91	91-113 451-25					91-113 460-01 91-129 661-15
91-056 278-90	91-113 464-91	91-113 451-25	91-053 869-93				91-113 460-01
91-056 278-90	91-113 464-91	91-113 451-25					91-113 460-01
91-056 278-90	91-113 464-91	91-113 451-25					91-113 460-01
91-056 278-90	91-113 464-91	91-113 451-25					91-113 460-01
91-056 278-90	91-113 464-91	91-113 451-25					91-113 460-01
91-056 179-91**							91-113 460-01
91-056 179-91**							91-113 460-01 91-129 661-15
91-056 278-90	91-113 464-91	91-113 451-25					91-010 192-01
				91-053 758-21	91-053 738-24		91-113 460-01
91-056 179-91**				91-053 758-21	91-053 738-24		91-113 460-01
91-056 278-90	91-113 464-91	91-113 451-25		91-491 627-21			91-113 460-01
91-056 278-90	91-113 464-91	91-113 451-25		91-491 627-21			91-113 460-01

\* Pour les machines avec -900/16 et /56 la plaque à aiguille porte le numéro: 91-058 872-93.

\* Para máquinas con -900/16 y /56, la placa de aguja lleva el Nº 91-058 872-93

\*\* Pour pouvoir monter simultanément deux appareils, on peut sur demande recevoir le support nº 91-053 908-90.

\*\* Para poder montar simultáneamente dos aparatos, se suministra, sobre demanda, el soporte Nº 91-053 908-90.

10/71 = je nach Nadelabstand ändert sich die Form (z. B. beim Stoffschieber die Anzahl der Zahnreihen)  
 = Certain design features change according to the needle gauge (e. g. the number of tooth rows on the feed dog)  
 = La forme est fonction de l'écartement des aiguilles (par ex. le nombre des rangées de dents de la griffe)  
 = La forma varía de acuerdo con la distancia entre agujas (p.e. el número de hileras de dientes en el transportador)

10/2 = Nadelabstand bei Bestellung angeben  
 = State needle gauge on order  
 = Indiquer écartement des aiguilles à la commande  
 = Indíquese en los pedidos la distancia entre agujas

14/7 = Nadel diagonalabstand bei Bestellung angeben  
 = Please state diagonal needle distance on order  
 = Préciser l'espacement diagonal des aiguilles à la commande  
 = Indíquese en los pedidos la distancia diagonal entre agujas

91-019 865-93

10/2

91-019 872-91

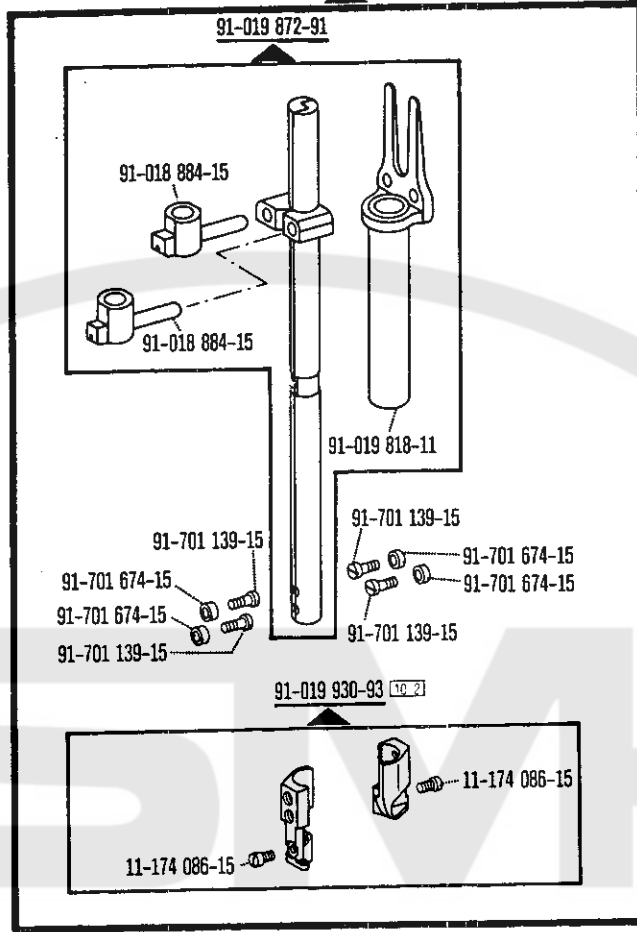

91-113 458-93

10/2

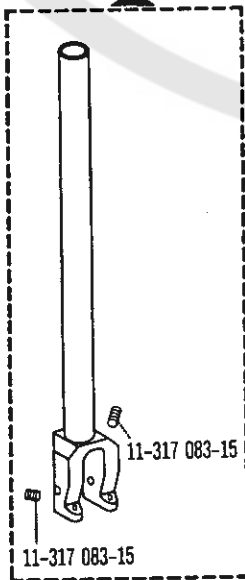

91-710 005-93

10/2

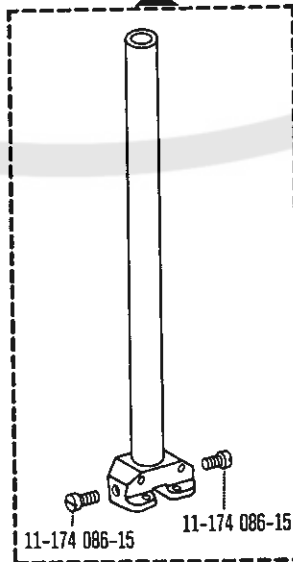

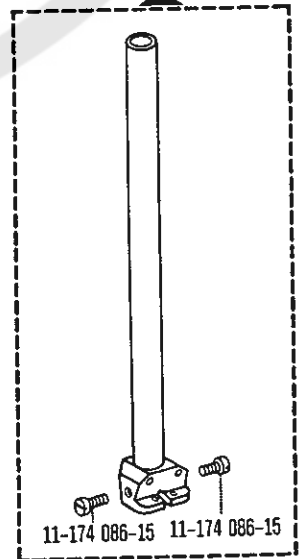

91-710 117-93

10/2

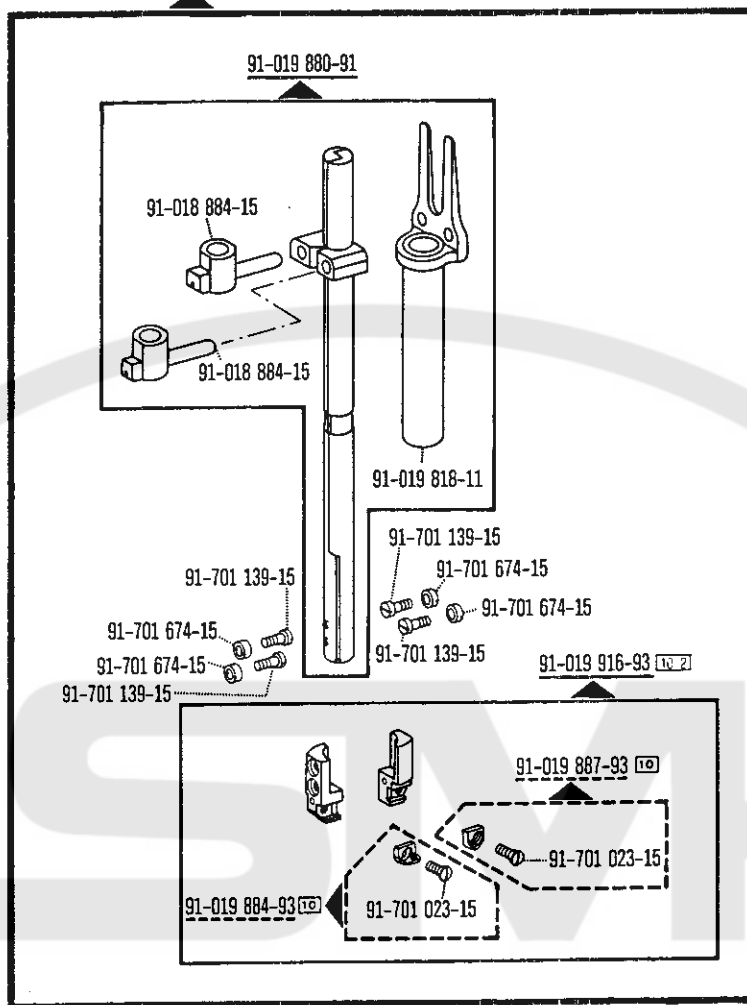

91-019 879-93 



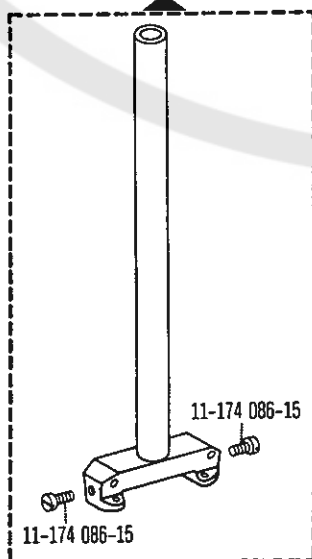

91-710 261-93 



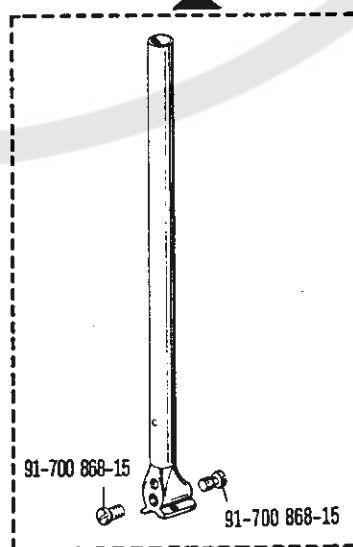

91-715 538-93   



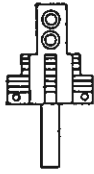

91-026 583-04  





91-040 340-04  





91-045 492-04  





91-046 714-04    
 = 2,4 - 3,2 mm





91-046 714-04    
 = 6,0 - 36,0 mm





91-046 734-04  



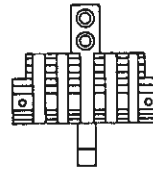

91-047 261-93    



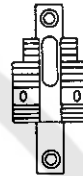



91-047 314-04  





91-491 442-04  



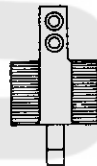

91-491 877-04    





91-026 574-93    







91-040 341-04  





91-045 493-04  





91-046 715-04    





91-046 735-04  





91-048 910-93  





91-058 092-04  



91-058 871-04  



91-058 872-93  

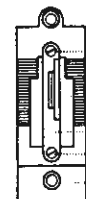

91-000 508-15

91-048 909-93

91-000 508-15

91-058 873-04

91-491 443-04 

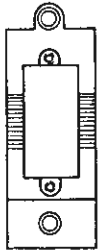

91-491 766-04 



91-491 878-04 

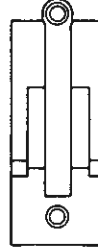

91-491 935-04 



91-026 578-03 

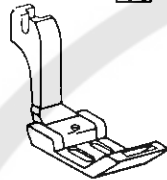

91-026 758-23 

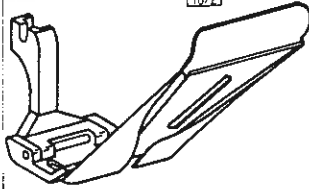

91-026 804-03 

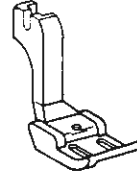

91-026 805-03 

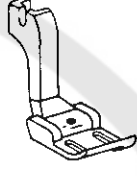

91-026 850-03 

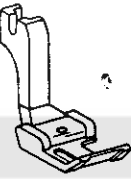

91-040 584-03 



91-040 662-03 



91-040 663-03 

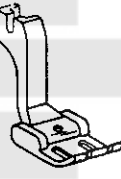

91-040 791-04 



91-040 811-03 

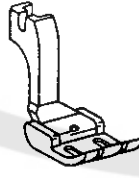

91-040 845-03 

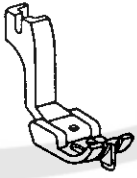

91-041 615-24 

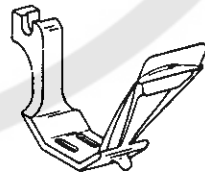

91-043 767-93 

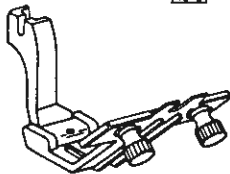

91-046 895-93 

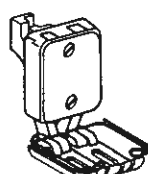

91-046 900-93 

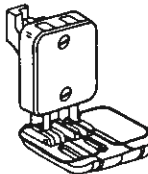

91-046 905-93 

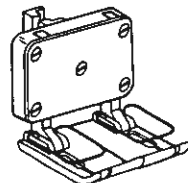

Unterklassen-Übersicht / Table of subclasses / Table des sous-classes / Table de sous-classes

91-051 080-03 4 10/2



91-051 376-03 4 5 10/2

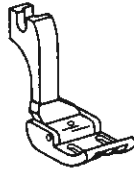

91-051 516-93 4 10/2

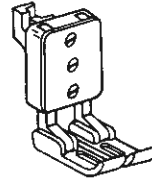

91-051 517-93 4 10/2

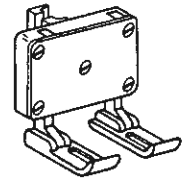

91-054 560-03 4 5  
10/2

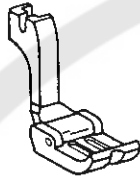

91-054 590-93 4 10/2

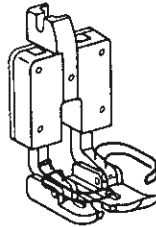

91-054 626-93 4 10/2

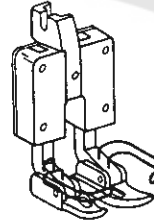

91-054 778-93 4 10/2

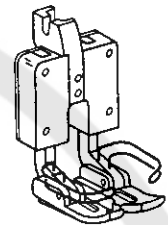

91-055 400-93 4 10/2

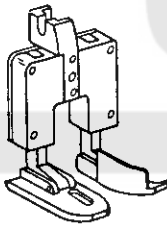

91-057 245-03 4 10/2

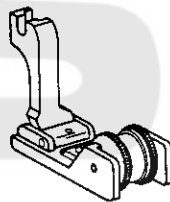

91-488 243-93 4 5  
10/2

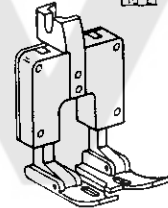

91-489 707-03 4 10/2

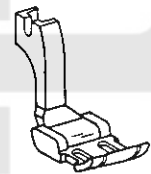

91-491 581-93 4 5  
10/2

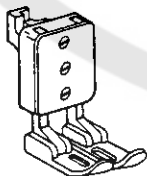

91-492 535-93 4 10/2

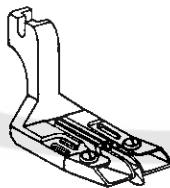

91-026 588-23 5 10/2

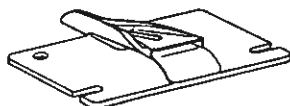

91-040 140-23 5

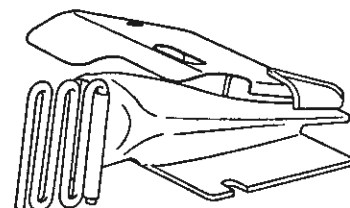

91-040 142-23 [5] [10] [2]

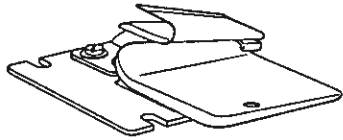

91-040 158-23 [5]

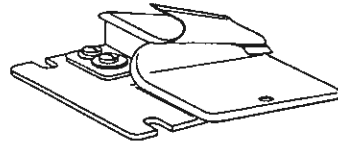

91-040 316-93 [4] [5] [10] [2]

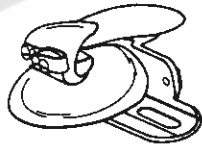

91-700 799-15

[2] [3] 91-040 317-93

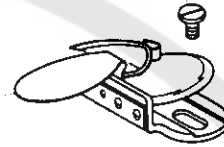

91-040 656-23 [4] [5] [10] [2]

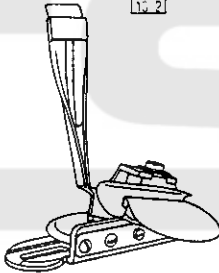

91-040 657-23

[4] [5] [10] [2]

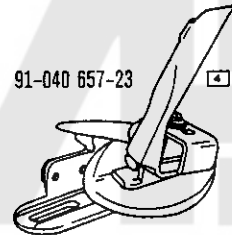

91-040 769-23 [5] [10] [2]

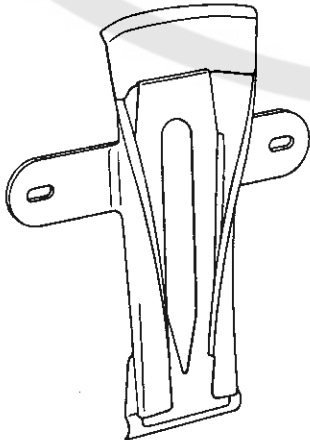

91-040 814-23 [4] [5] [10] [2]

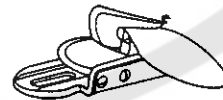

91-040 815-23 [5] [10] [2]

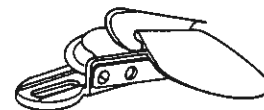

91-041 731-23

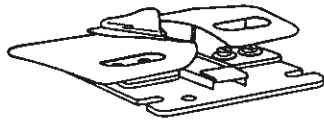

91-041 732-23

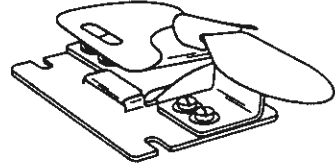

91-041 848-23



91-041 906-23

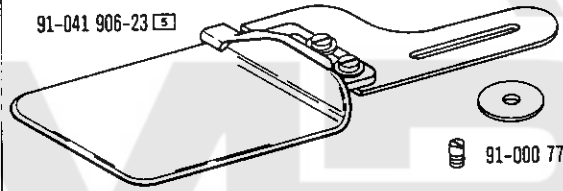

91-700 824-25



91-040 624-25



91-028 036-



91-000 775-15

91-041 982-25

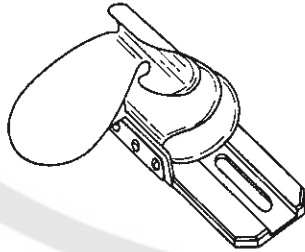

91-042 068-23

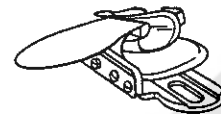

91-042 217-93

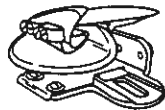

91-042 218-93

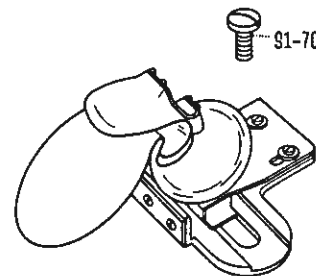

91-700 799-15

91-042 350-24 [5]

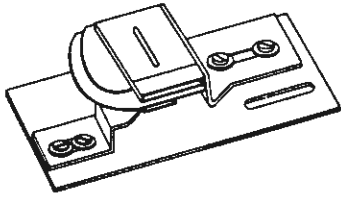

91-042 369-21 [5]

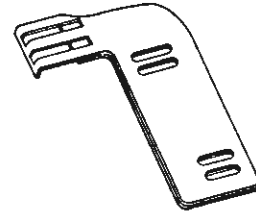

91-042 429-23 [5]

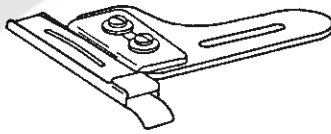

91-042 614-93 [5] [10] [2]

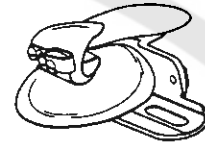

91-042 615-93 [5]

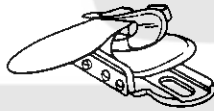

91-042 848-23 [5] [10] [2]

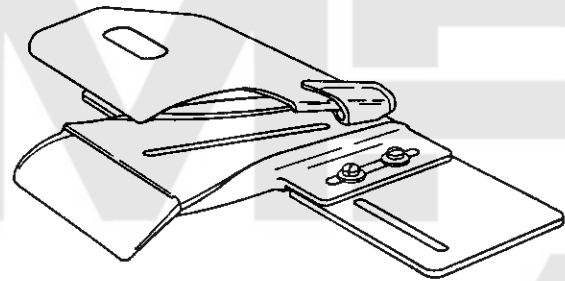

91-043 408-23 [5]

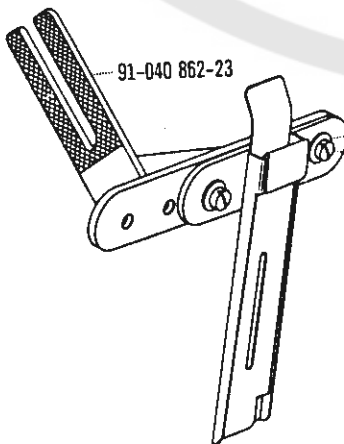

91-040 862-23

12-315 110-15  
91-000 089-25

91-044 308-24 [5]

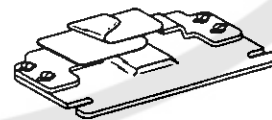

91-044 438-93 [5] [10] [2]

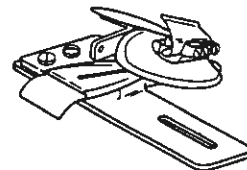

91-044 479-24 [5]

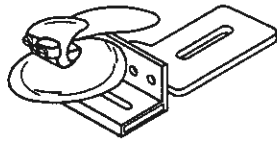

91-044 734-23 [5] [10] [2]

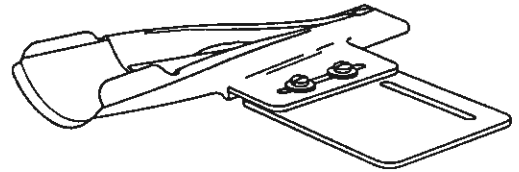

91-044 989-23 [5]

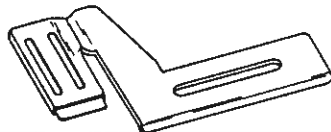

91-045 235-23 [5]

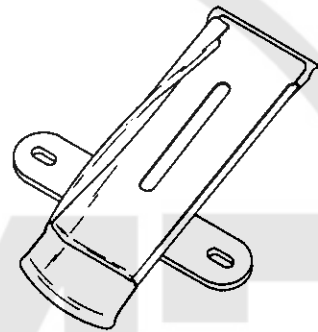

91-046 014-23 [5]

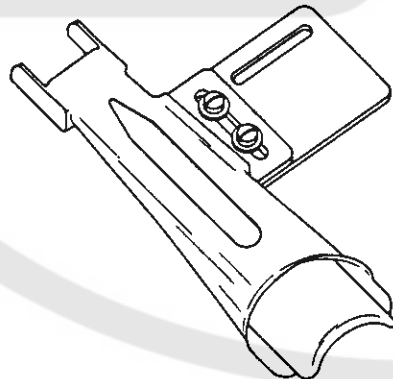

91-100 285-25

91-100 285-25

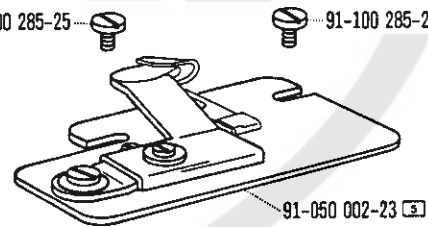

91-050 002-23 [5]

91-050 003-23 [5]

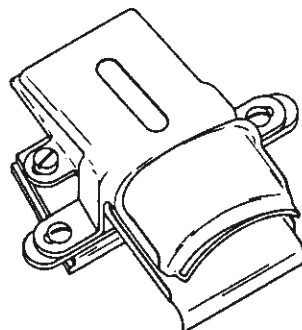

91-053 065-23 [5]

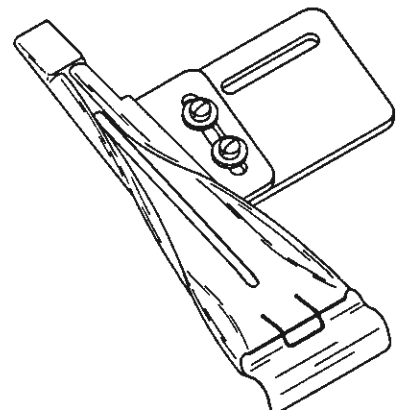

91-053 131-23 [5]

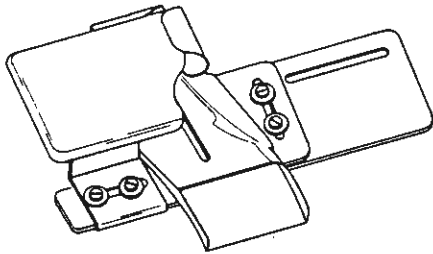

91-053 351-24 [5]

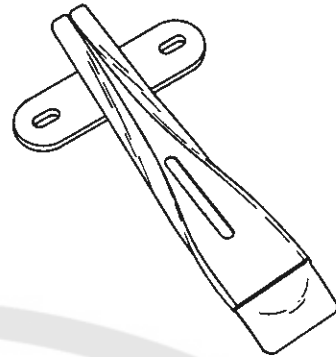

91-053 414-23 [5]

- 91-000 521-25 [Screw]
- 91-028 036-25 [Washer]
- 91-000 521-25 [Screw]
- 91-028 036-25 [Washer]

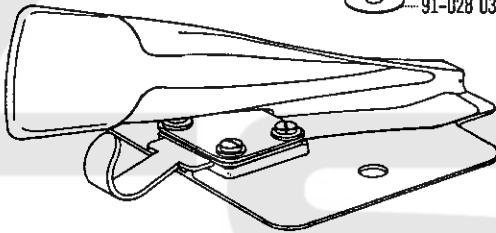

91-053 531-24 [5]

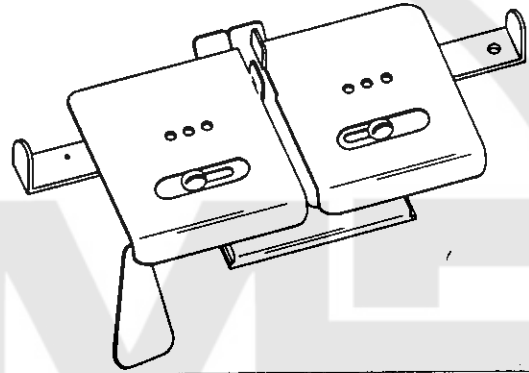

91-053 534-93 [5]

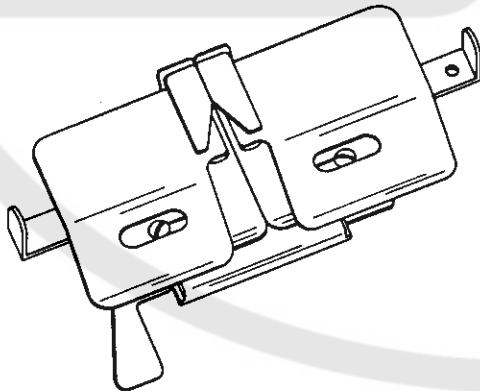

91-053 537-24 [5]

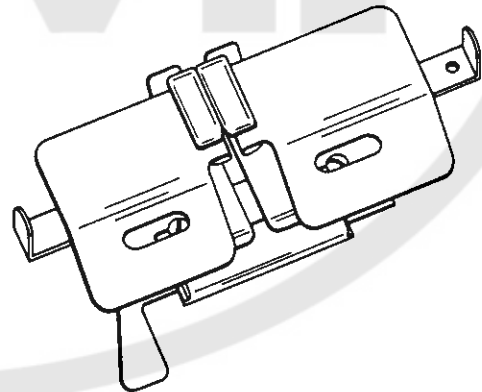

91-053 732-23 [5]

- 91-000 521-25 [Screw]
- 91-028 036-25 [Washer]
- 91-000 521-25 [Screw]
- 91-028 036-25 [Washer]

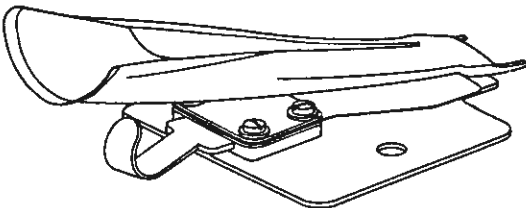

91-053 736-23 [5]

- 91-000 521-25 [Screw]
- 91-028 036-25 [Washer]
- 91-000 521-25 [Screw]
- 91-028 036-25 [Washer]

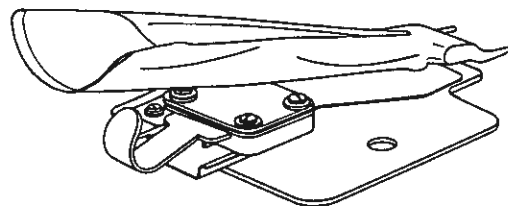



91-053 859-23 

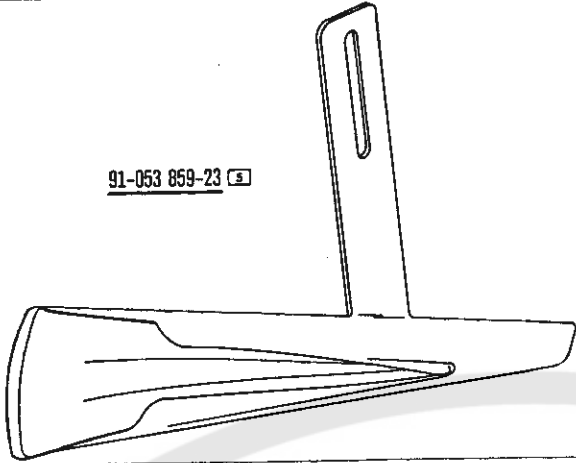

91-053 874-23 

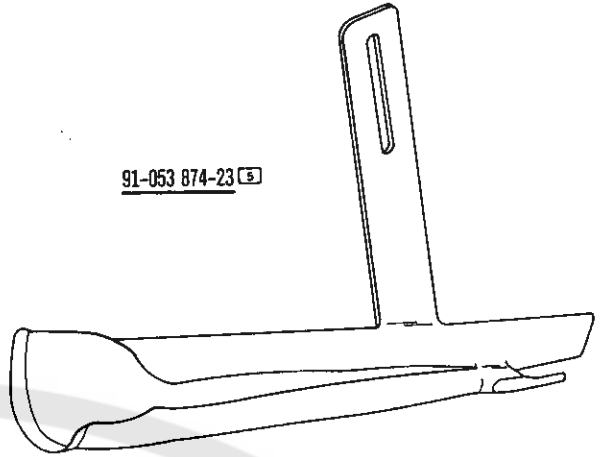

91-053 880-23 

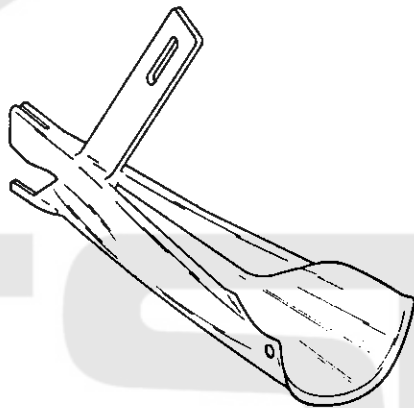

91-056 494-23 

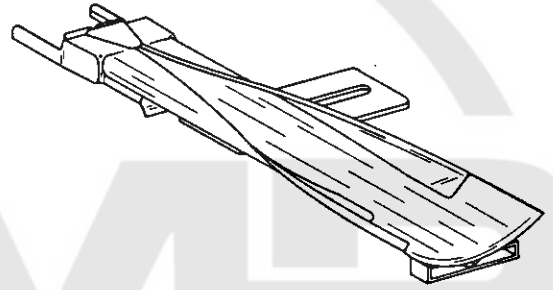

91-056 037-13 

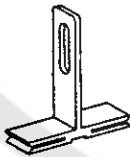

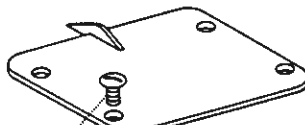

91-056 514-21 



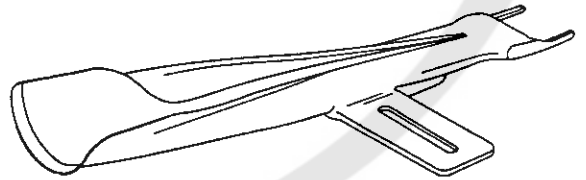

91-700 335-25

91-491 269-23 

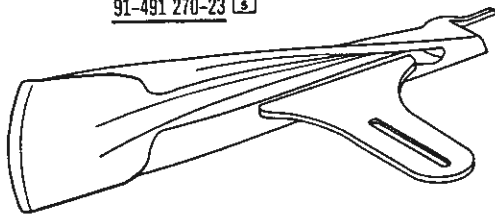

91-491 270-23 



91-491 277-23 

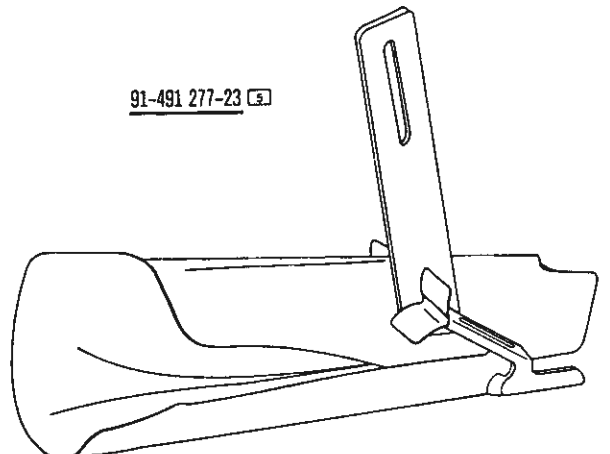

91-491 278-23 [5]

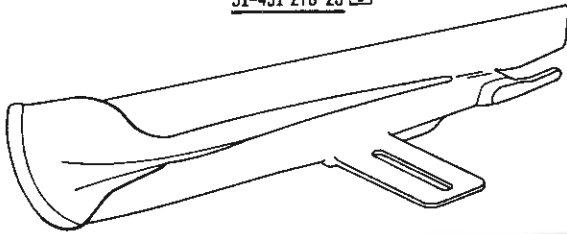

91-491 279-23 [5]

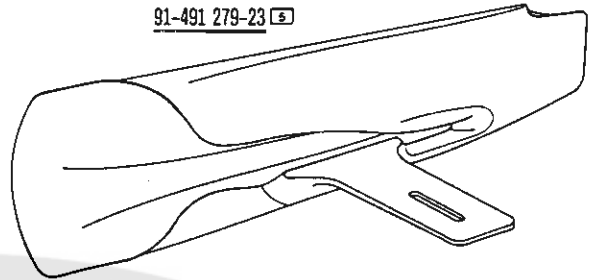

91-491 284-23 [5]

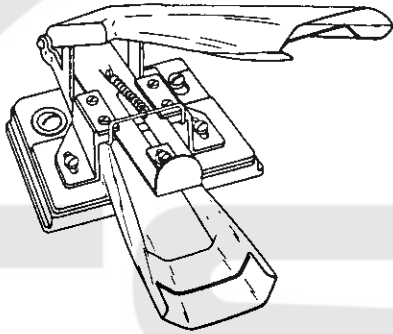

91-491 934-23 [5]

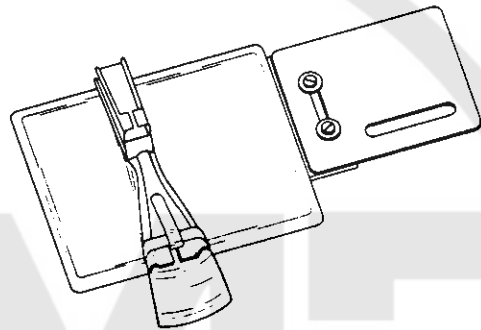

91-493 211-23 [5]

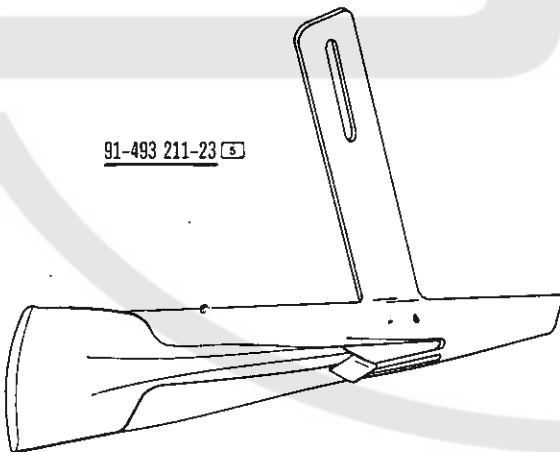

91-494 106-23 [5]

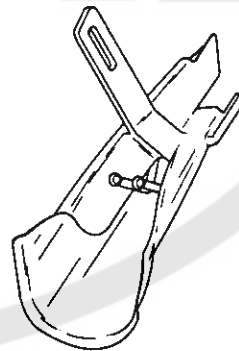

91-040 528-90

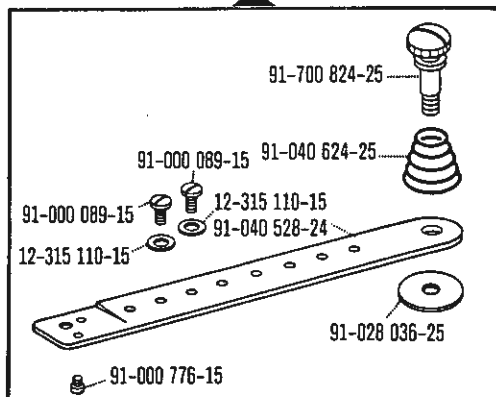

91-040 862-90

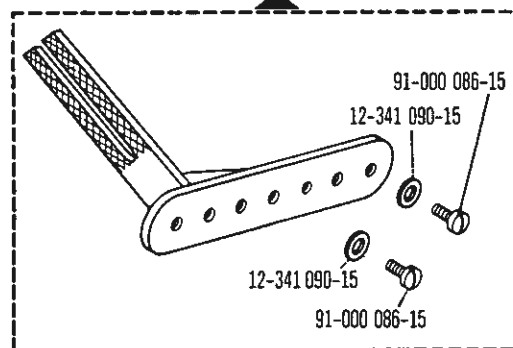

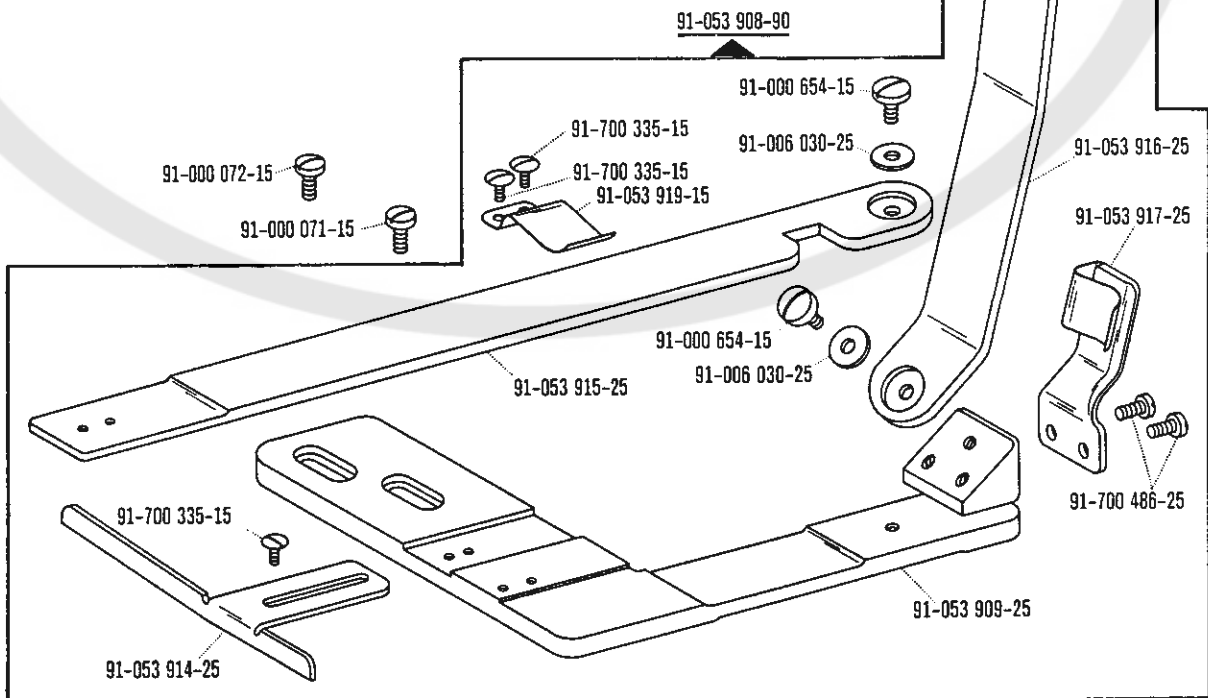
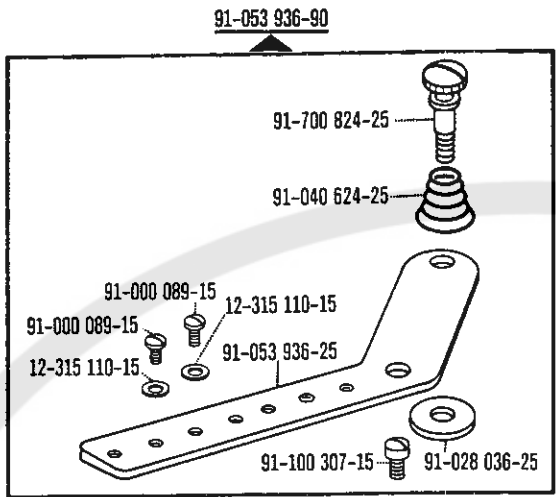

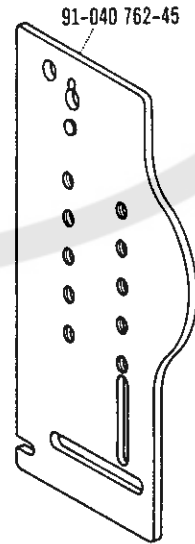
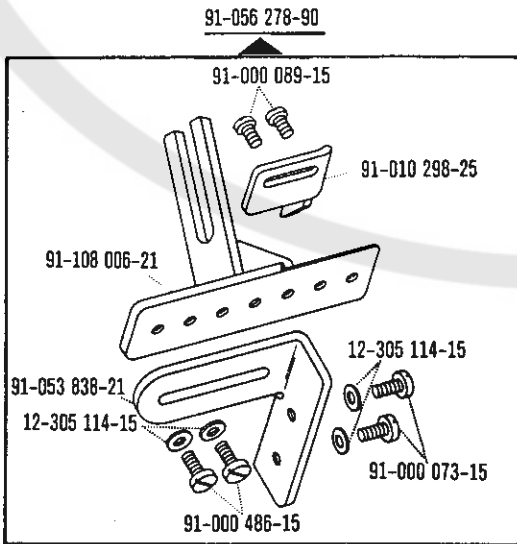
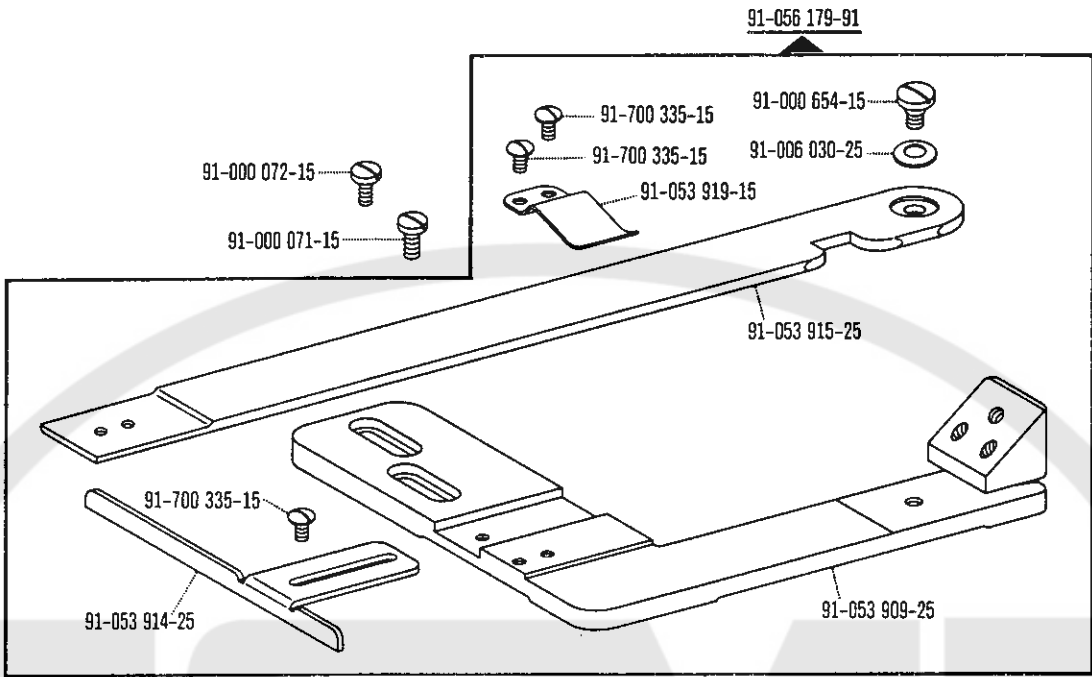

91-040 766-91

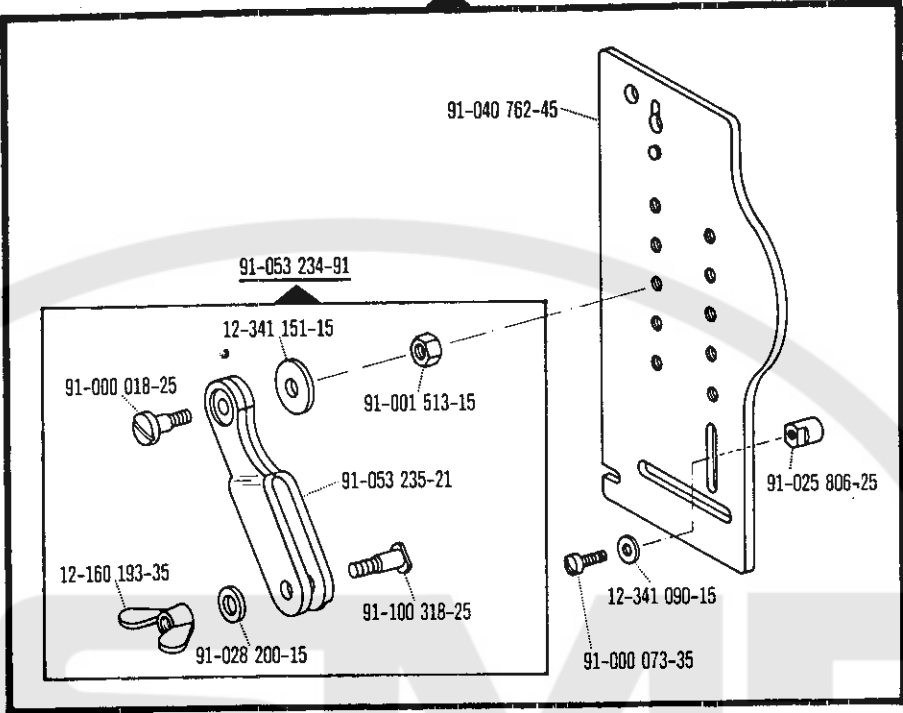

91-113 464-91

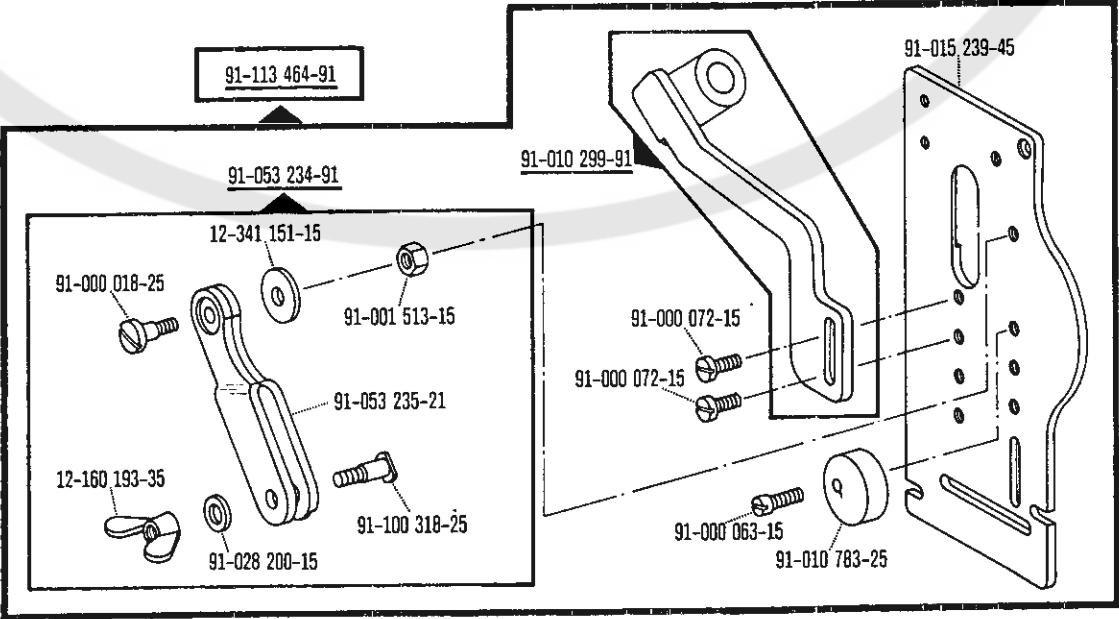

91-491 565-45

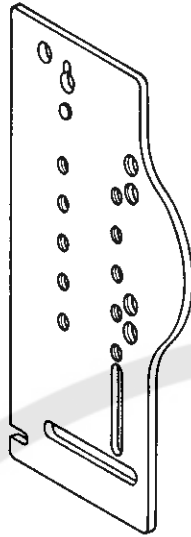

91-040 207-91

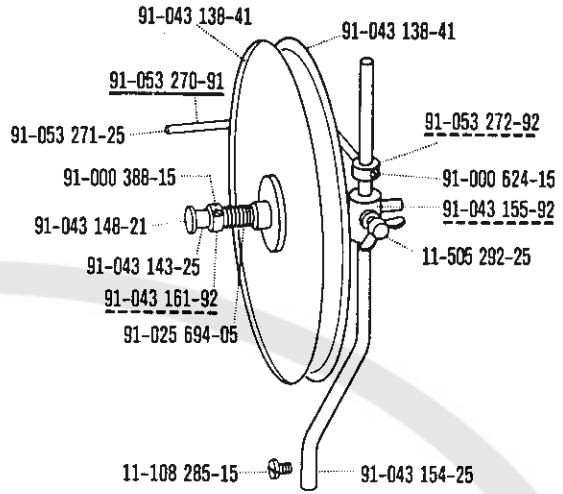

91-056 532-91

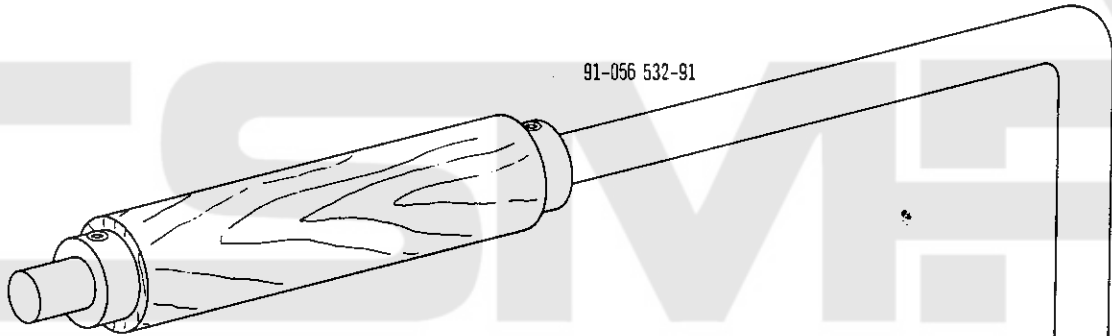

91-041 644-91

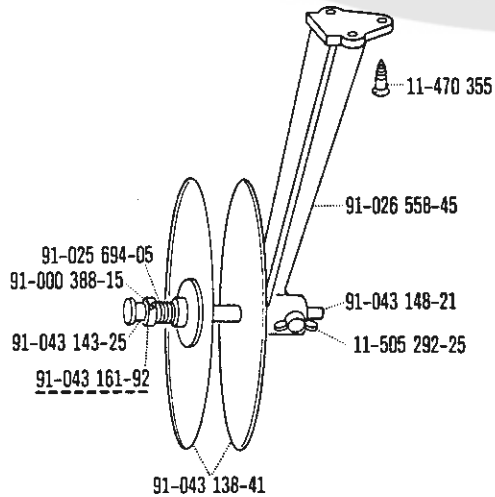

91-056 524-11

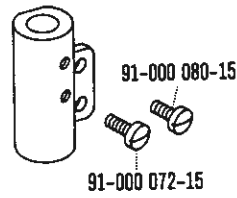

11-470 247-15

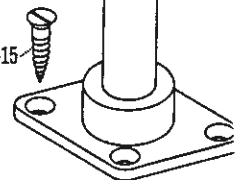

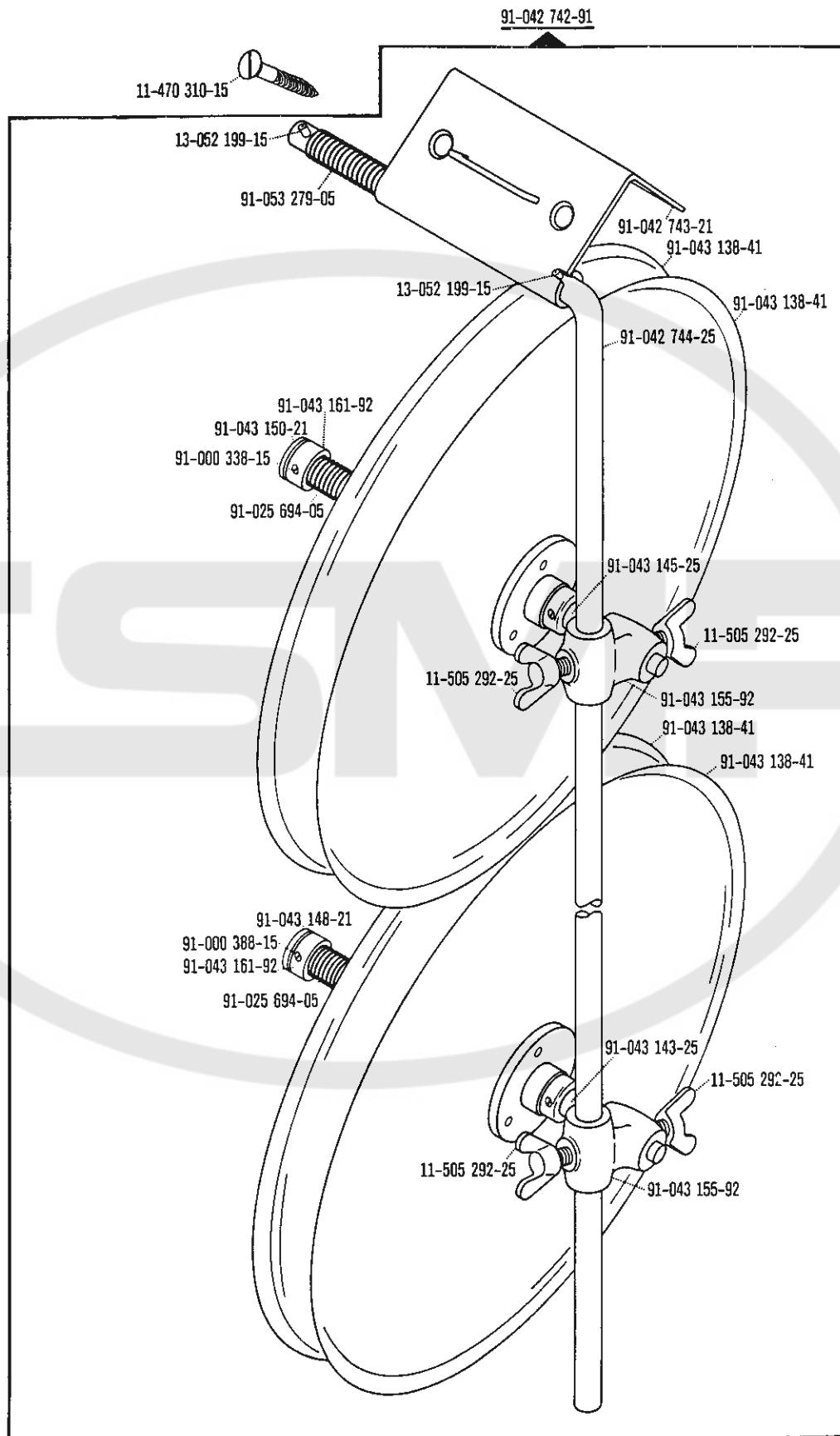

91-053 325-91

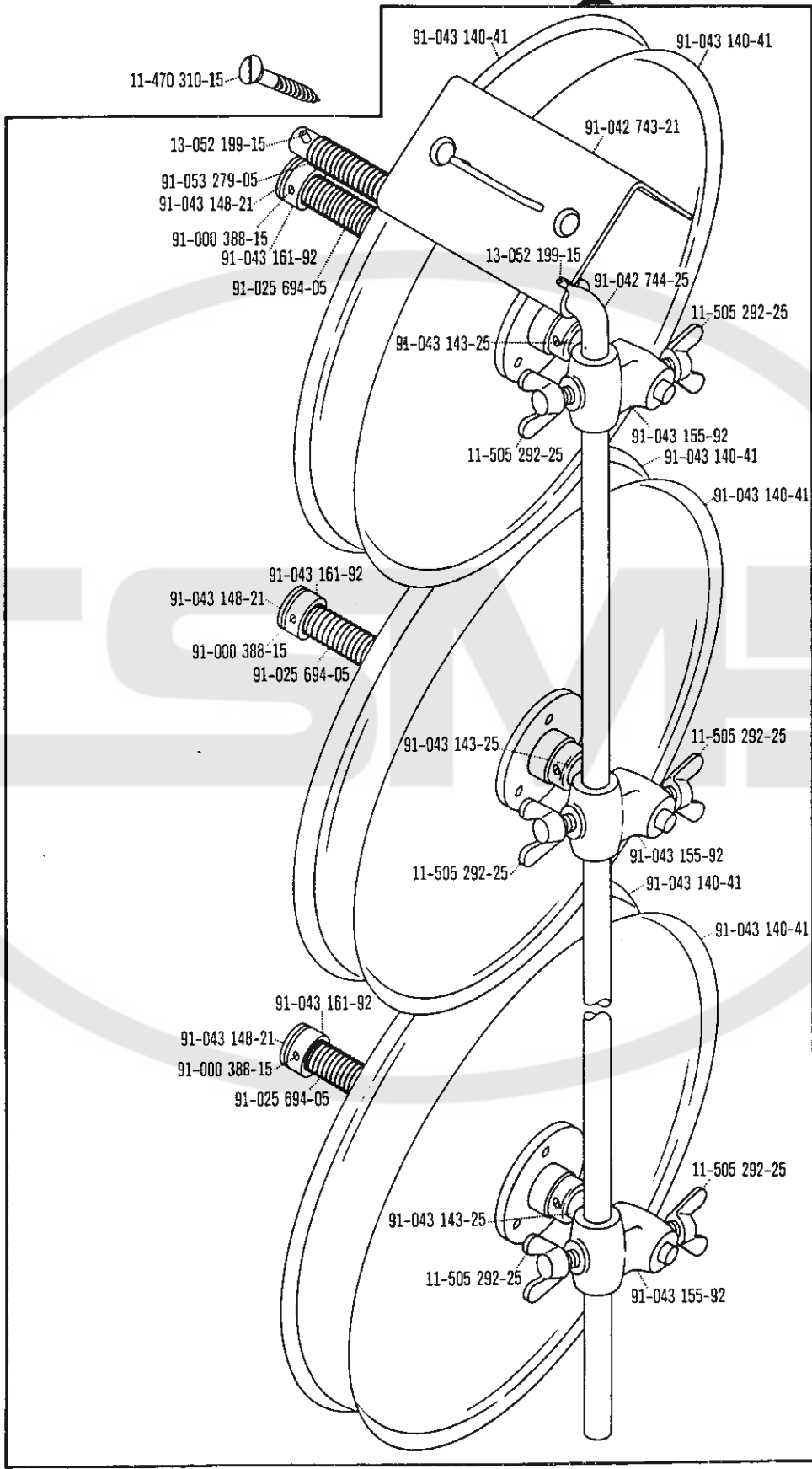

11-470 310-15

91-043 140-41

91-043 140-41

13-052 199-15

91-042 743-21

91-053 279-05

91-043 148-21

91-000 388-15

91-043 161-92

91-025 694-05

13-052 199-15

91-042 744-25

11-505 292-25

91-043 143-25

11-505 292-25

91-043 155-92

91-043 140-41

91-043 140-41

91-043 161-92

91-043 148-21

91-000 388-15

91-025 694-05

91-043 143-25

11-505 292-25

11-505 292-25

91-043 155-92

91-043 140-41

91-043 140-41

91-043 161-92

91-043 148-21

91-000 388-15

91-025 694-05

91-043 143-25

11-505 292-25

11-505 292-25

91-043 155-92



Unterklasseübersicht / Table of Contents

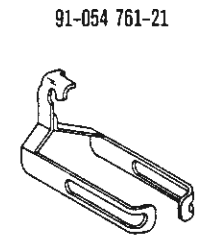
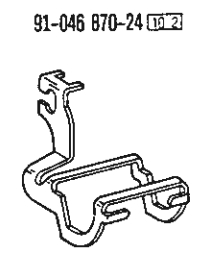
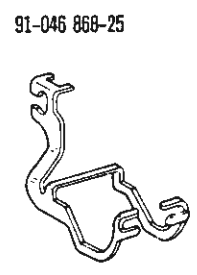
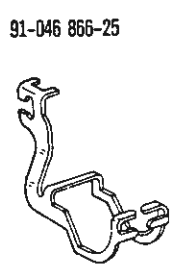
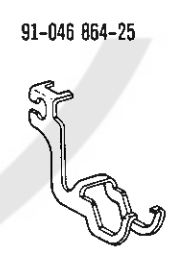
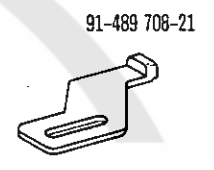
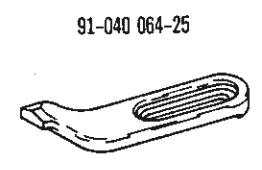
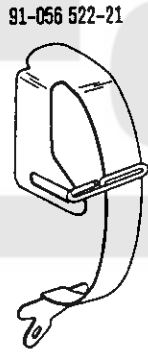
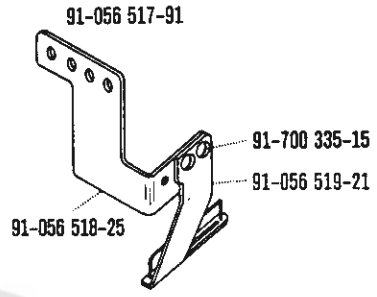
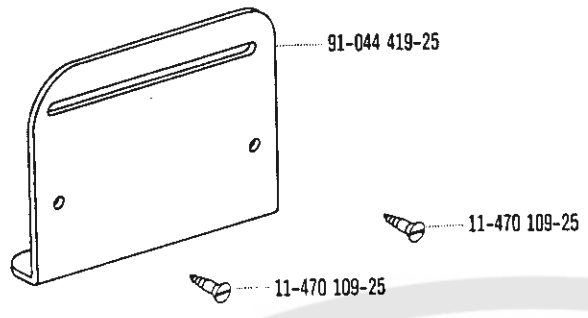

91-055 259-91

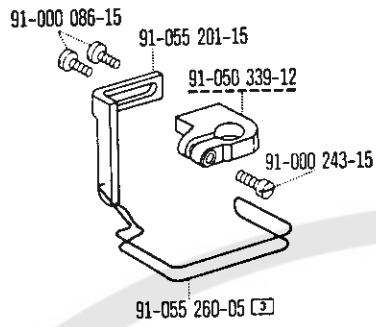

91-055 261-91

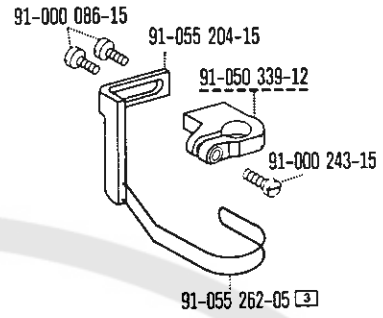

91-108 583-91

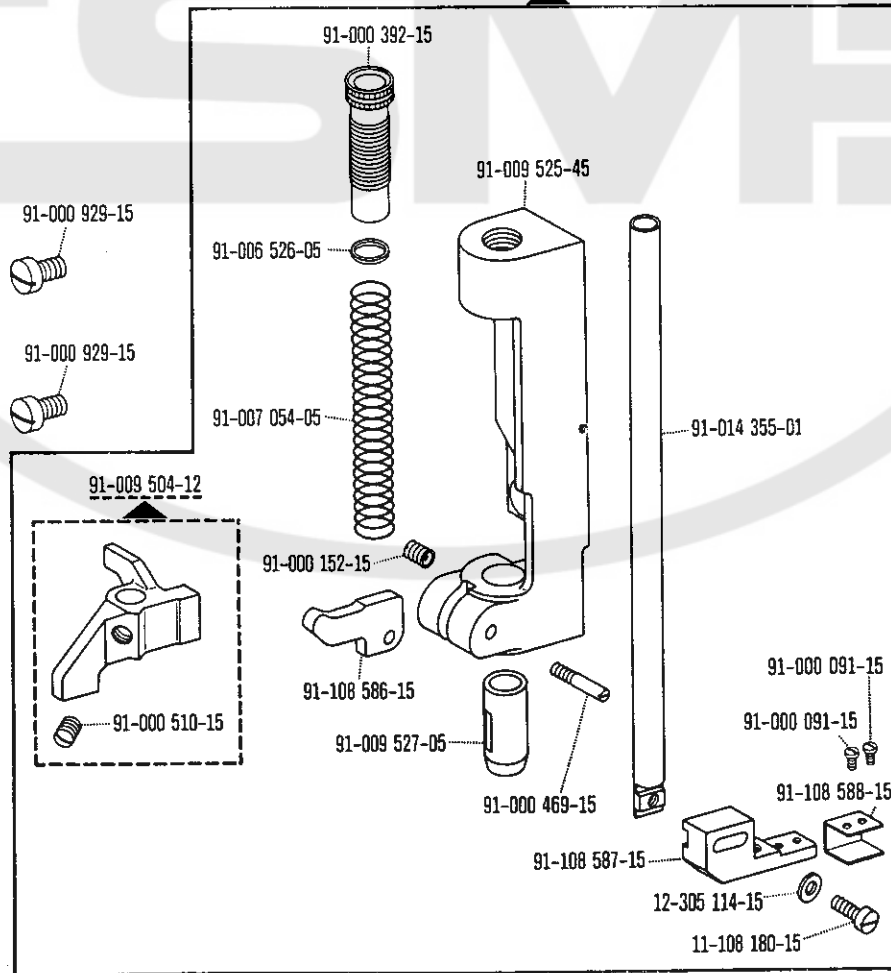

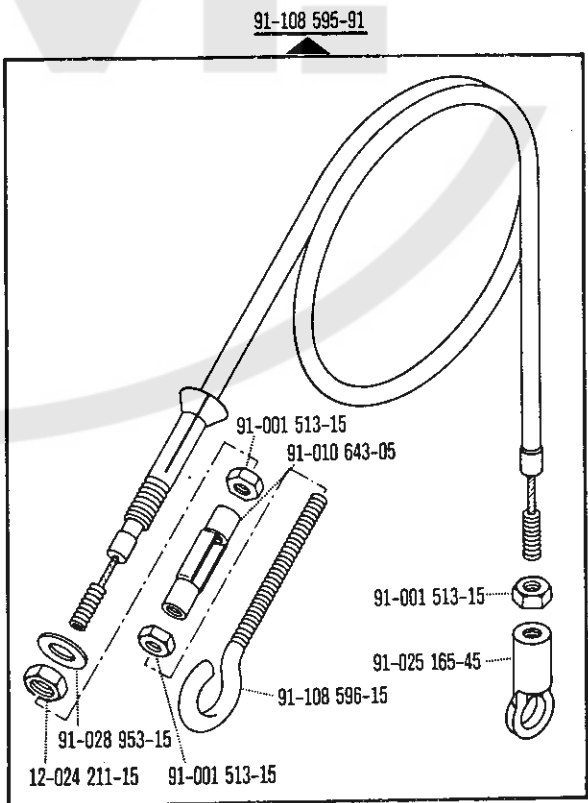
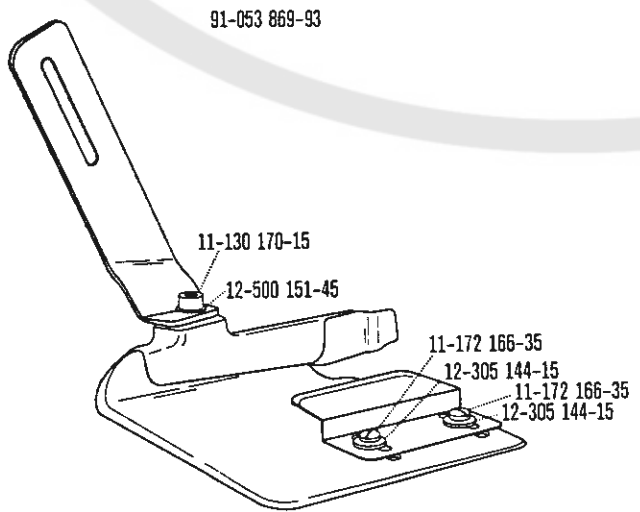
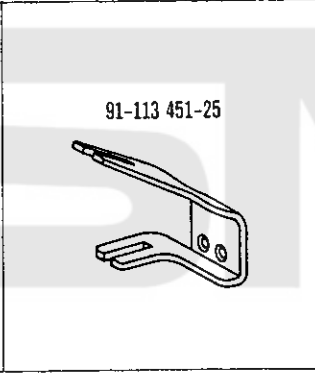
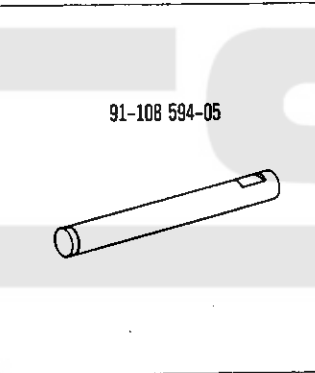
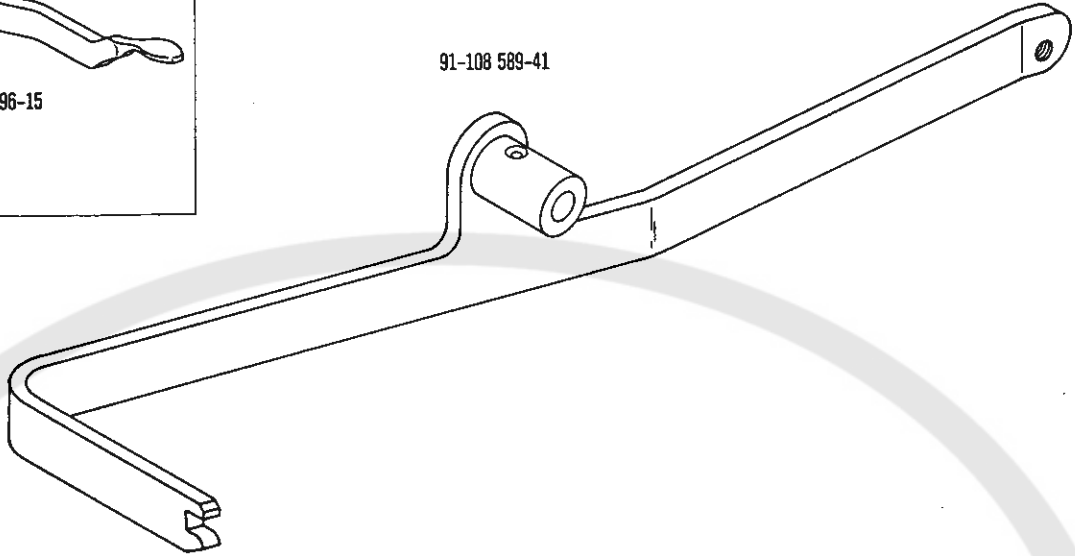
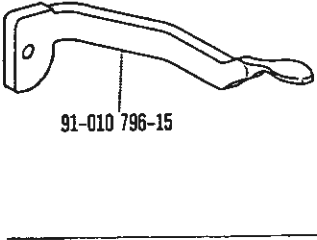

91-053 758-21

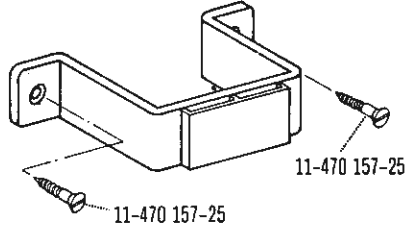

91-491 627-21

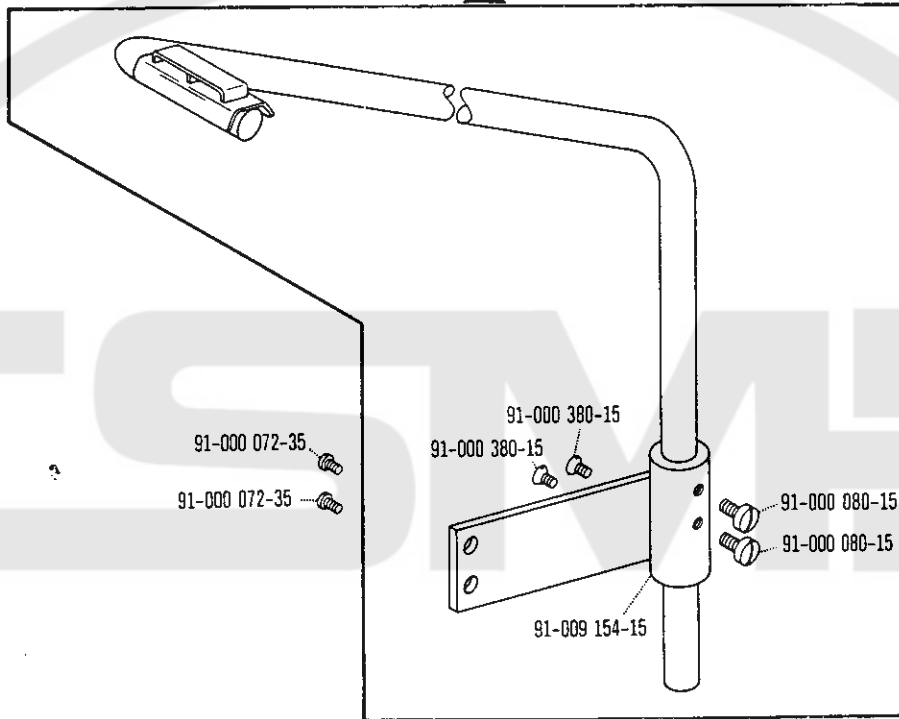

91-053 738-24

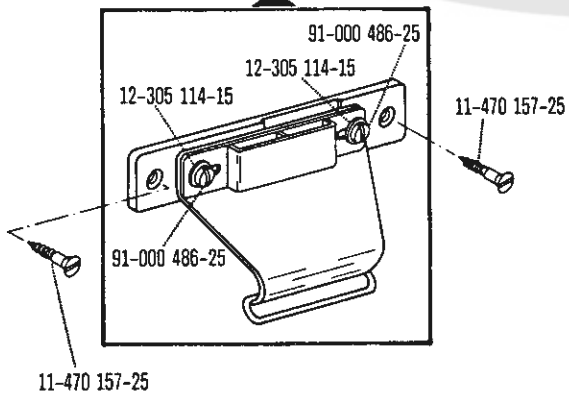

91-010 192-01



91-010 273-01



91-113 460-01



91-129 661-15

